



# Installation manual

Montageanleitung • Notice de montage • Istruzioni per il montaggio  
Manual de montaje • Monteringsanvisning • Installatiegids

## Verkaufsstand 273 cm

Elementhaus • Maison à modules • Casetta in elementi • Cobertizo • Redskapsbod • Element huis

### Width 273 x Depth 190 cm

Breite/Tiefe • Largeur/Profondeur • Lunghezza/Profondità • Ancho/Profundidad • Bredde/Dybde • Breedte/Diepte

### Log thickness 16 mm

Bohlenstärke • Épaisseur des murs • Spessore delle pareti • Grosor de pared • Tykkelse • Wanddicke



The producer shall have the right to make technical changes to the product • Technische Änderungen vorbehalten • Le producteur réserve le droit d'effectuer des modifications techniques au produit • Il produttore mantiene il diritto di apportare modifiche tecniche al prodotto • Reservado el derecho a modificaciones técnicas • Produsent forbeholder seg retten til å endre tekniske egenskaper ved produktet • Alle rechten en technische wijzigingen voorbehouden

## 1 General information



Dear client,

We are glad that you have decided in favour of our garden house!

**Please read the assembly manual carefully before proceeding with the house installation!** You will thus avoid problems and will not waste time.

### Recommendations:

- Keep the house package until its complete assembly in a dry place, but not in direct contact with the ground, protected from weather conditions (moisture, the sun, etc.). Do not keep the house package in a heated room!
- When selecting the garden house location, make sure that the house will not be subjected to extreme weather conditions (areas of strong snowfall or winds); otherwise you should attach the house (for instance, with anchors) to the subsoil.



### Warranty

Your house is made from high quality fir and delivered in the natural (unprocessed) form. If, despite our thorough inspection, you should have complaints, please submit the filled out control sheet and purchase invoice to the product seller.

**ATTENTION: Please be sure to keep the documentation accompanying the house package! The control sheet includes the control number of the house. We can only review complaints if you submit the control number of the house to the seller!**

The warranty does not cover:

- Peculiarities of wood as a natural material
- Wooden details already painted (processed with a wood preservative)
- Wooden details containing whole branches that do not endanger the stability of the house
- Colour tone variations caused by wood structure differences that do not influence wood lifetime
- Wooden details containing (caused by drying) small cracks/gaps that do not pass through and do not influence the structure of the house
- Twisted wooden details if they can nevertheless be installed
- Roof and floor boards that may have on their concealed surfaces some non-planed areas, colour differences and waning
- Complaints resulting from an incompetent manner of the installation of the house or the house subsiding due to an incompetently made foundation
- Complaints caused by introducing self-initiative changes to the house, such as the deformation of wooden details and doors/windows due to an incompetent manner of wood processing; the attachment of storm braces too rigidly, doorframes being screwed onto wall logs, etc.

**The complaints covered by the warranty are satisfied to the extent of replacing the deficient/faulty material. All other demands will be excluded!**



## Garden house painting and maintenance

Wood is a natural material, growing and adapting depending on weather conditions. Large and small cracks, colour tone differences and changes, as well as a changing structure of wood are not errors, but a result of wood growing and a peculiarity of wood as a natural material.

Unprocessed wood (except for foundation joists) becomes greyish after having been left untouched for a while, and can be turn blue and become mouldy. To protect the wooden details of your garden house, you must immediately process them with a wood preservative.

We recommend that you cover the floor boards in advance with a colourless wood impregnation agent, especially the bottom sides of the boards, to which you will no longer have access when the house is assembled. Only this will prevent moisture penetration.

We definitely recommend that you also process the doors and windows with a wood impregnation agent, and do that namely both inside and outside! Otherwise the doors and windows can become twisted.

After the house assembly is completed, we recommend for the conclusive finishing a weather protection paint that will protect wood from moisture and UV radiation.

When painting, use high quality tools and paints, follow the paint application manual and manufacturer's safety and usage instructions. Never paint a surface in strong sunlight or rainy weather. Consult a specialist regarding paints suitable for unprocessed softwood and follow the paint manufacturer's instructions.

Having been properly painted, your garden house's lifetime will increase substantially. We recommend that you inspect the house thoroughly once every six months.

## 2 Preparation for assembly

### Tools and preparation of components

To assemble the garden house, you will need the following tools:



assembly aid



ladder



hammer



water-level



screwdriver



saw



knife



measuring tape



pliers



drill

**ADVICE:** To avoid splinters, we recommend that you wear the corresponding protective gloves during the assembly process.



**We wish you total success with the garden house installation and much joy with this house for many years to come!**

## 1 Generelles



### Sehr geehrter Kunde,

es freut uns, dass Sie sich für unser Gartenhaus entschieden haben!

**Es ist wichtig, diese Aufbauanleitung vollständig durchzulesen, bevor Sie mit dem Aufbau Ihres Blockhauses beginnen!** So vermeiden Sie Probleme und unnötigen Zeitverlust.

#### Tipps:

- Lagern Sie den Bausatz bis zur endgültigen Montage trocken und nicht direkt auf dem Erdboden, geschützt vor Witterungseinflüssen (Nässe, Sonneneinwirkung, etc.). Ware bitte nicht in einem geheizten Raum aufbewahren!
- Achten Sie bei der Standortwahl darauf, dass das Blockhaus nicht extremen Witterungsbedingungen (Gebiete mit starkem Wind) ausgesetzt ist, gegebenenfalls sollten Sie das Blockhaus zusätzlich mit dem Fundament verankern.



### Gewährleistung

Ihr Haus besteht aus hochwertigem nordischen Fichtenholz und wird unbehandelt geliefert. Wenn es trotz unserer sorgfältigen Werkskontrolle zu Reklamationen kommen sollte, legen Sie Ihrem Fachhändler den ausgefüllten Kontrollschein mit Ihrer Einkaufsrechnung vor!

**WICHTIG: Bitte unbedingt die Dokumentation aufbewahren! Auf dem Kontrollschein finden Sie die Kontrollnummer des Hauses. Es ist möglich die Reklamation nur dann als Garantiefall zu behandeln, wenn Sie die Kontrollnummer Ihrem Fachhändler weitergeben!**

#### Abweichungen die keinen Reklamationsgrund darstellen:

- Holz ist ein Naturprodukt, daher gehören die naturgegebenen Beanstandungen nicht unter Garantie.
- Materialreklamationen werden nicht akzeptiert, wenn bereits ein Anstrich erfolgte!
- Äste die mit dem Holz fest verwachsen sind.
- Holzverfärbungen, ohne das dadurch die Lebensdauer beeinflusst wird.
- Risse /Trockenrisse die nicht durchgehend sind und nicht die Konstruktion beeinflussen.
- Verdrehungen des Holzes vorausgesetzt es lässt sich noch verarbeiten.
- An den nicht sichtbaren Seiten von Dach- und Fussbodenbrettern können die Bretter ungehobelt sein, es können Farbunterschiede und Baumkanten vorkommen.
- Spätere Reklamation durch unsachgemässe Montage, Absacken des Hauses durch unsachgemässe Fundamente und Gründungen sind ausgeschlossen.
- Eigene Veränderungen am Haus wie z.B. Verzug von Bohlen und Fenstern/Türen durch fehlenden Holzanstrich oder Aufbau, die zu starre Befestigung der Sturmleiste, Verschrauben der Türrahmen mit den Blockbohlen usw., sind ausgeschlossen.

**Ansprüche auf Gewährleistung beschränken sich auf den Austausch von fehlerhaftem Material. Alle weiteren Ansprüche sind ausgeschlossen!**



## Anstrich und Pflege

Holz ist ein Naturprodukt und arbeitet unterschiedlich. Merkmale wie grobe und feine Maserungen, Farbschattierungen und Veränderungen sowie Verwachsungen haben Ihren Ursprung im Wuchs des Baumes. Sie sind bei Hölzern, die in der freien Natur wachsen, normal und deshalb nicht als Fehler, sondern vielmehr als Eigentümlichkeit des Naturwerkstoffes Holz anzusehen.

Das unbehandelte Holz (ausser Lagerhölzer) wird nach einiger Zeit vergrauen, kann verbläuen und verschimmeln. Um ihr Blockhaus zu schützen, sollten Sie es mit geeigneten Holzschutzmitteln behandeln.

Um Ihr Gartenhaus optimal zu schützen, empfehlen wir die Bodenbretter vorgängig mit einer farblosen Grundierung zu behandeln. Besonders die Unterseite, welche nach der Montage nicht mehr zu erreichen ist. Nur auf diese Weise wird das Eindringen der Feuchtigkeit verhindert.

Wir empfehlen unbedingt auch Türen und Fenster mit einer Grundierung zu behandeln. Es ist sehr wichtig sowohl die Innen- als auch die Aussenseiten der Türen und Fenster auf einmal zu streichen! Andernfalls können sie sich verziehen.

Nach dem Aufbau empfehlen wir Ihnen die Aussenhaut (ohne Dach) zu Grundieren, sobald diese trocken ist sollten Sie das Haus mit einer Holzlasur streichen, die das Holz vor Feuchtigkeit und UV-Strahlung schützt.

Beim Anstrich benutzen Sie hochwertiges Werkzeug und Farbe, beachten Sie die Sicherheits- und Verarbeitungshinweise des Farbenherstellers. Streichen Sie nie in praller Sonne oder beim regnerischen Wetter. Lassen Sie sich ausführlich bei Ihrem Fachhändler über den Holzschutz für unbehandelte Nadelhölzer beraten.

Durch einen regelmässigen Anstrich beeinflussen Sie im Wesentlichen die Lebensdauer Ihres Gartenhauses. Wir empfehlen Ihnen auch eine halbjährliche Inspektion des Gartenhauses.

## 2 Vorbereitung zur Aufbau

### Werkzeuge und Vorbereitung der Details

Beim Aufbau brauchen Sie Folgendes:



Montagehelfer



Stehleiter



Hammer



Wasserwaage



Schraubenzieher



Säge



Messer



Bandmass



Zange



Bohrer

**HINWEIS:** Um Verletzungen durch eventuelle Holzsplitter zu vermeiden, tragen Sie bitte während der Montage entsprechende Schutzhandschuhe.



**Wir wünschen Ihnen nun viel Spass und Erfolg beim Aufbau und jahrelange Freude mit Ihrem Gartenhaus!**

## 1 Généralités



**Cher client,**

Nous sommes heureux que votre choix se soit porté sur notre maison de jardin!

**Il est important de lire entièrement cette notice de montage avant de commencer la construction de votre maisonnette en poutres!** Vous vous éviterez ainsi des problèmes et des pertes de temps inutiles.

### Conseils:

- Avant son montage définitif, entreposez le kit de construction au sec et pas directement sur la terre, en le protégeant contre les intempéries (humidité, rayonnement du soleil, etc.). Ne pas conserver la marchandise dans un local chauffé!
- Au moment de choisir l'endroit de montage, veillez à ce que la maisonnette en poutres ne soit pas exposée à des conditions atmosphériques extrêmes (zones exposées à des vents forts). Le cas échéant, il serait bon d'ancrer la maisonnette en poutres dans des fondations.



### Garantie

Votre maisonnette est réalisée en bois d'épicéa nordique de haute qualité et elle vous est livrée non traitée. Si elle devait donner lieu à des réclamations, malgré les soins apportés à notre contrôle en usine, nous vous demandons de remettre à votre revendeur spécialisé le bon de contrôle rempli et votre facture d'achat!

**IMPORTANT: Veuillez impérativement conserver la documentation! Vous trouverez sur le bon de contrôle le numéro de contrôle de la maisonnette. La réclamation ne peut être traitée dans le cadre de la garantie que si vous communiquez le numéro de contrôle à votre revendeur spécialisé!**

Ecartis qui ne constituent pas un motif de réclamation:

- Le bois est un produit naturel, ce qui fait que les réclamations reposant sur des phénomènes naturels ne tombent pas sous le coup de la garantie.
- Les réclamations concernant les matériaux ne sont pas acceptées si une peinture a déjà été appliquée!
- Nœuds qui sont inhérents au bois.
- Décolorations du bois qui n'exercent pas d'influences sur la durée de vie.
- Fissures / fentes de retrait qui ne sont pas traversantes et qui n'exercent pas d'influences sur la construction.
- Déformations du bois, sous réserve qu'il puisse encore être mis en œuvre.
- Sur les faces non visibles des planches du toit et du plancher, il se peut que les planches ne soient pas rabotées, on peut observer des différences de couleur et des flaches.
- Une réclamation tardive résultant d'un montage incorrectement réalisé, d'un affaissement de la maisonnette par suite de fondations et de soubassements incorrectement réalisés, est exclue.
- Une réclamation suite à des modifications apportées de son propre chef à la maisonnette, comme par exemple une déformation des madriers et des fenêtres/portes par suite d'une peinture du bois ou d'une construction insuffisantes, la fixation trop rigide du contreventement, le vissage des dormants sur les madriers, etc., est exclue.

**Les recours en garantie se limitent au remplacement du matériel défectueux. Tous les autres recours sont exclus!**



## Peinture et entretien

Le bois est un produit naturel qui travaille de façon variable. Des caractéristiques telles que les madrures grossières et fines, les nuances de couleurs et les modifications, de même que les imbrications, ont leur origine dans la croissance du bois. Dans le cas de bois qui poussent en pleine nature, ces caractéristiques sont normales et ne doivent par conséquent pas être considérées comme des défauts mais, au contraire, comme une particularité de ce matériau naturel qu'est le bois.

Au bout de quelque temps, le bois non traité (à l'exception des longrines) prendra une teinte grise, il pourra bleuir et moisir. Pour protéger votre maisonnette en poutres, il convient que vous le traitiez avec des produits de protection du bois appropriés.

Pour protéger votre maison de jardin de façon optimale, nous vous conseillons de traiter préalablement les planches du plancher à l'aide d'un apprêt incolore. En particulier la face inférieure à laquelle vous ne pourrez plus avoir accès après le montage. Ce n'est que de cette façon que l'on empêche l'humidité de pénétrer.

Nous conseillons de traiter impérativement les portes et les fenêtres également à l'aide d'un apprêt. Il est très important de peindre en une seule fois aussi bien les faces intérieures que les faces extérieures des portes et des fenêtres! Dans le cas contraire, elles pourront se déformer.

Une fois le montage effectué, nous vous conseillons de revêtir l'extérieur (sans le toit) d'un apprêt. Dès que cet apprêt sera sec, vous devrez revêtir votre maison d'un glacis pour bois qui protégera le bois contre l'humidité et le rayonnement ultraviolet.

Pour la peinture, n'utilisez qu'un outillage et une peinture de haute qualité, et respectez les consignes de sécurité et de mise en œuvre du fabricant de peintures. Ne peignez jamais en plein soleil ou lorsque le temps est à la pluie. Faites-vous conseiller de façon détaillée par votre revendeur spécialisé quant à la protection à utiliser pour les conifères non traités.

En refaisant régulièrement la peinture, vous augmentez sensiblement la durée de vie de votre maison de jardin. Nous vous conseillons également une inspection semestrielle de votre maison de jardin.

## 2 Préparation au montage

### Outils et préparation des détails

Pour le montage, vous avez besoin du matériel suivant:



une personne pour vous aider au montage



échelle double



marteau



niveau à bulle d'air



tournevis



scie



couteau



mètre-ruban



pince



foret

**REMARQUE:** Pour éviter les blessures provoquées par d'éventuels éclats de bois, nous vous demandons de porter des gants de protection correspondants lors du montage.



**Nous vous souhaitons beaucoup de moments heureux, une installation réussie et beaucoup d'années joyeuses dans votre maisonnette!**

## 1 Generalidades



### Estimado cliente,

¡Nos alegra que haya elegido una casita nuestra!

**¡Por favor, lea atentamente el manual de montaje antes de empezar a armarla!** Esto le evitará problemas y pérdida de tiempo.

#### Recomendaciones:

- Hasta que empiece a armar la casa mantenga el paquete en su embalaje y en un lugar seco evitando el contacto directo con el suelo, protéjalo de la intemperie (humedad, sol, etc.) ¡No deje el paquete en lugares calientes!
- Al seleccionar la ubicación de la cabaña en su jardín, evite lugares donde quede expuesta a efectos fuertes de la intemperie (nevadas o vientos fuertes), en caso contrario será necesario fijar la casa al suelo (por ejemplo, con anclajes).



### Garantía

Su casita está hecha de abeto de alta calidad y se entrega al natural (sin pulir). Si, a pesar de nuestras minuciosas inspecciones, descubriese defectos, presente llene la ficha de control y preséntela al vendedor junto con la factura.

**ATENCIÓN: ¡Por favor, conserve la documentación adjunta al paquete! La ficha de control incluye el número de serie de la casita. ¡Sus quejas serán atendidas solamente si suministra al vendedor el número de control de su casita!**

#### La garantía no cubre:

- Peculiaridades naturales de la madera
- Piezas que hayan sido pintadas (tratadas con preservantes)
- Piezas con nudos que no afectan la estabilidad de la casita
- Piezas con diferentes tonos de color debidos a la estructura de la madera y que no afectan su vida útil
- Piezas con pequeñas grietas/fisuras (causadas por el secado) que no atraviesan la pieza y no afectan la estructura de la casita
- Piezas de madera torcidas que pueden ser usadas en la casa
- Tablas del techo o suelo que, en su superficie oculta, puedan tener zonas sin pulir, variaciones de color o desgastes
- Problemas provocados por el montaje incompetente de la casita o hundimiento de la casita debido a cimentación deficiente
- Problemas causados por alteraciones arbitrarias en la casa, como deformación de las piezas de madera o de las ventanas o puertas como consecuencia del tratamiento incompetente de la madera; ajuste excesivo de los ganchos de tormenta, atornillado de los marcos de las puertas a los troncos de las paredes, etc.

**Las reclamaciones por problemas cubiertos por la garantía se limitan a reemplazar los materiales deficientes / defectuosos. ¡No se aceptan otras reclamaciones!**





## Pintado y mantenimiento de la casa

La madera es un material natural que crece y se adapta a las condiciones climáticas. Grietas pequeñas o grandes, diferencias y cambios en los matices de colores y sus alternancias estructurales no son fallas, sino resultados del crecimiento y de las características de la madera como material natural.

Con el tiempo la madera sin procesar (excepto las vigas de cimentación) y sin usar se vuelve gris o azul y criar moho. Proteja su casa tratándola de inmediato con un preservante de maderas.

Antes de armar la casa se recomienda tratar las tablas del suelo con un agente impregnante incoloro de madera, especialmente su lado oculto, al que no tendrá acceso después de armarla. Sólo así puede proteger las tablas contra la humedad.

¡También recomendamos tratar las puertas y ventanas con un agente impregnante tanto por dentro como por fuera! De lo contrario las puertas y ventanas se pueden deformar.

Después de armar la casa recomendamos, para su acabado final, usar pintura protectora para exteriores para evitar daños por humedad y radiación UV.

Al pintar su casa utilice únicamente herramientas y pinturas de alta calidad, siga los manuales de pintura y las instrucciones de seguridad y uso del fabricante. No se debe pintar bajo luz solar intensa o bajo la lluvia. Consulte un especialista sobre pinturas para madera suave no procesada y siga las instrucciones del fabricante de la pintura.

Pintando la casa apropiadamente prolongará considerablemente su vida útil. Se recomienda revisar cuidadosamente de la cabaña cada seis meses.

## 2 Preparativos para el ensamblado

### Herramientas y la preparación de los componentes

Para montar la casa se necesita lo siguiente:



Ayudante



Escalera



Martillo



Nivel



Destornillador



Sierra



Cuchillo



Metro



Alicate



Taladro

**Consejo:** Para protegerse de las astillas se recomienda usar guantes protectores durante el trabajo.



**¡Le deseamos éxito en el montaje de su casa y que la disfrute por muchos años!**

## 1 In generale



**Gentile Cliente,**

siamo veramente lieti che Lei abbia scelto la nostra casetta di legno per il Suo giardino!

**E' importante leggere accuratamente le istruzioni prima di iniziare con il montaggio della Sua casetta di legno!** In tal modo eviterà qualsiasi problema e perdita di tempo.

### **Consigli:**

- Conservare il kit in luogo asciutto e non direttamente sul pavimento, protetto da agenti atmosferici (acqua, sole ecc.) fino al montaggio definitivo. Non conservare il prodotto in ambienti riscaldati !
- Nella scelta del luogo di collocamento, fare attenzione che la casetta non sia esposta a condizioni atmosferiche estreme (vento forte); eventualmente ancorare la casetta ulteriormente con le fondamenta.



### **Garanzia**

La vostra casetta è stata realizzata con pregiato legno di abete rosso nordico e viene consegnata in stato non trattato. Qualora, nonostante il nostro accurato controllo in fabbrica, dovessero sorgere reclami, sarà necessario presentare al negoziante il certificato di controllo compilato insieme alla fattura d'acquisto!

**IMPORTANTE: E' assolutamente necessario conservare la documentazione! Sul certificato di controllo è riportato il numero di controllo della casa. Reclami possono essere evasi in garanzia unicamente se comunicherete il numero di controllo al vostro negoziante!**

#### Divergenze che escludono motivo di reclamo:

- Il legno è un prodotto naturale e pertanto le contestazioni relative allo stato naturale non rientrano nella garanzia.
- Reclami relativi al materiale non vengono accettati una volta verniciato!
- Rami cresciuti nel legno.
- Scolorimenti del legno che non influiscono sulla durata.
- Crepe /fessure non passanti che non compromettono la costruzione.
- Nodi nel legno a condizioni che possa ancora essere lavorato.
- Nei punti invisibili del tavolame tetto e pavimento sono ammesse tavole non piallate; sono inoltre ammesse differenze di colore e spigoli dell'albero.
- Reclami successivi dovuti a montaggio non conforme, cedimento della casetta a causa di fondamenta errate sono esclusi.
- I reclami causati introducendo modifiche proprie alla casetta, p.es. deformazione di tavole e finestre/porte dovute ad un montaggio incompetente, fissaggio troppo rigido del listello antivento, avvitarmento dei telai delle porte con le tavole di legno ecc., sono esclusi.

**Le rivendicazioni di garanzia sono limitate alla sostituzione del materiale difettoso. Ogni altra rivendicazione è esclusa!**



## Verniciatura e cura

Il legno è un prodotto naturale e si muove in modo diverso. Caratteristiche quali venature grosse e fini, sfumature di colore e cambiamenti nonché nodi sono dovuti alla crescita dell'albero. Sono del tutto normali nei legni che crescono all'aperto, e pertanto non sono da considerare difetti ma piuttosto una caratteristica del legno naturale.

Il legno non trattato (ad eccezione dei travetti) diventa grigio col tempo, può scolorirsi e fare la muffa. Per proteggere la vostra casetta di legno, è consigliabile trattarla con opportuni preservanti per legno.

Per proteggere al meglio la vostra casetta da giardino, consigliamo di trattare le tavole del pavimento preventivamente con un colore di fondo neutro, in particolare la parte inferiore che non sarà più raggiungibile dopo il montaggio. Solo in questo modo la penetrazione di umidità potrà essere evitata.

Consigliamo di trattare in ogni caso anche porte e finestre con un colore di fondo. E' molto importante verniciare sia il lato interno che quello esterno delle porte in un'unica soluzione, altrimenti potrebbero deformarsi !

Dopo il montaggio, consigliamo di applicare uno strato di fondo sulla pelle esterna (senza tetto), non appena il medesimo si sarà asciugato, verniciare la casetta con una velatura per legno per proteggere il legno dall'umidità e dalle radiazioni UV.

Per la verniciatura, usare attrezzi e vernici di qualità e rispettare le istruzioni di sicurezza e applicazione del produttore della vernice. Non verniciare in pieno sole o in caso di pioggia. Farsi consigliare dettagliatamente dal venditore sulla protezione di legni di conifera non trattati.

Con una regolare verniciatura aumenterete notevolmente la durata della vostra casetta da giardino. Consigliamo un'ispezione semestrale della casetta.

## 2 Preparazione al montaggio

### Attrezzi e preparazione dei particolari

#### Attrezzi occorrenti:



aiutante



scala doppia



martello



livella a bolla d'aria



cacciavite



sega



coltello



metro



pinza



trapano

**AVVERTENZA:** Per evitare lesioni causate da eventuali schegge di legno, portare guanti di protezione durante il montaggio.



**Vi auguriamo successo nel montaggio della casa e speriamo che la godrete per molti anni!**

## 1 Generell informasjon



**Kjære kunde,**

det gleder oss at du valgte hagehuset vårt!

**Les monteringsanvisningen grundig før du går i gang med å sette sammen huset!** For å unngå problemer og bruk av unødig tid.

### Husk:

- La huset være innpakket og oppbevar det på et tørt sted, ikke i direkte kontakt med bakken og godt beskyttet mot vær og vind (fuktighet, solskinn osv.), helt frem til arbeidet påbegynnes. Huspakken må ikke oppbevares i et oppvarmet rom!
- Kontrollerer leveransen mot delelisten for å se om alle delene er inkludert, før du starter monteringen. Sorter delene i samsvar med monteringsanvisningen og legg de fire sidene ut i forhold til monteringsrekkefølgen.



### Garanti

Dette huset er fremstilt av høykvalitets gran (furu brukes i enkelte tilfeller) og leveres ubehandlet. Dette huset har gjennomgått en grundig inspeksjon. Dersom du likevel skulle ha grunn til reklamasjon, ber vi deg fylle ut kontrollskjema og sende det sammen med kjøpsbeviset og kvitteringen til forhandleren.

**OBS: Sørg for å oppbevare all dokumentasjon som følger med huspakken! Husets serienummer er oppført på kontrollskjema. Vi kan kun behandle en reklamasjon dersom du sender husets serienummer til forhandleren!**

### Garantien dekker ikke:

- Særegenhet i treverket som et naturlig materiale
- Deler som allerede er behandlet (malt, grunnet)
- Deler av huset som inneholder hele kvister som ikke representerer en fare for husets stabilitet
- Variasjoner i fargetone som er forårsaket av forskjeller i trestrukturen og som ikke har betydning for treverkets levetid
- Deler av huset som sprekker på grunn av tørking, dvs. små sprekker/ riss som ikke er gjennomgående og som ikke påvirker husets struktur
- Deler av vridt tre som likevel kan monteres
- Tak- eller gulvplank som på skjulte overflater kan oppvise uhøvlede områder, fargeforskjeller og vankant
- Reklamasjoner fordi huset er blitt montert på ukyndig måte eller fordi huset sigrer på grunn av ukyndig utført fundament
- Reklamasjoner fordi det er blitt gjort endringer på huset på eget initiativ, som f.eks. formendringer på deler av tre eller dører/ vinduer. På grunn av ukyndig behandling av treverket; at stormavstivere er festet for stramt, dørkarmen er blitt skrudd inn i veggbord eller lignende.

**Reklamasjonene som dekkes av garantien er begrenset til å omfatte erstatning av manglende/ feil materiale. Alle andre krav er utelukket!**

**Produsent forbeholder seg retten til å endre tekniske egenskaper ved produktet.**



## Maling og vedlikehold av hagehuset

Tre er et naturlig materiale som beveger og tilpasser seg i forhold til værforholdene. Større eller mindre sprekker, fargeforskjeller og endringer samt ulikheter i treets struktur er ikke feil, men et resultat av treets vekst og en særegenhet i treverket som et naturlig materiale.

Ubehandlet treverk blir grått hvis det blir værende ubehandlet over tid og kan bli blått og begynne å råtne. For å beskytte treverket i hagehuset, må det før montering behandles med grunning.

Alle deler må behandles med grunning (f. eks. Visir) på alle sider (innvendig og utvendig), laftespor, not og fjær, før montering. Husk: Endeved 3-4 strøk vått i vått. Grunn vinduer og dører på alle sider. Grunn tak/gulvbord på alle sider.

### Hvorfor grunning?

Det er ekstra mye endeved i en laftehytte. Hvert eneste laftespor har endeved. Det er endeveden som tar til seg mest fuktighet i treverk. Ved produksjon av en laftehytte blir treverket tørket før det blir produsert. Dette gjør at delene lettere tar til seg fuktighet når pakken blir åpnet. Tørket trevirke som blir utsatt for fuktighetssvingninger vil ofte vri seg og skape spenninger i treverket som kan utløse mange problemer. En grunning sin viktigste funksjon er å redusere fuktoptak og dermed redusere spenningsproblemer. Den andre viktige funksjonen til en grunning er å hindre dannelse av sopp og råte. Dette oppstår gjerne på steder som har dårlig lufting, som f. eks. i laftesporene. Når huset er ferdig montert, må det ferdige huset behandles med et værbestandig malingsstrøk utvendig som beskytter treverket mot fuktighet og UV-stråler. Innvendig må huset etterbehandles i henhold til bruksmønster.

Bruk maleredskaper og maling/ beis av høy kvalitet når du maler huset. Følg anvisningene på spannet og produsentens sikkerhets- og bruksanvisninger. Du må aldri male en overflate i sterkt sollys eller i regnvær. Forhør deg hos en malerspesialist når det gjelder hvilken maling som egner seg for ubehandlet myktré, og følg anvisningene fra produsenten.

Dersom huset er blitt malt på riktig måte, vil husets levetid forlenges betraktelig. Vi anbefaler at du inspiserer huset grundig hvert halvår.

## 2 Foreberedelse før montering

### Verktøy og forberedelse før montering

Du trenger følgende verktøy ved montering:



monteringshjelp



stige



hammer



drill



vater



skrutrekker



sag



kniv



målebånd



avbiter tang













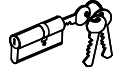
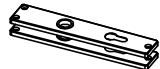

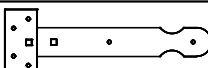
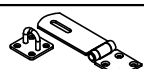





**OBS:** For å unngå flis anbefaler vi bruk av hansker under monteringen.



**Vi ønsker deg lykke til med det nye hagehuset og håper du får glede av det i mange år!**





Pos	SPECIFICATION-STÜCKLISTE-NOMENCLATURE-ELEMENTI-ESPECIFICACIÓN "ELD16-2719"	Pcs	Profile (mm)	Length (mm)
Fim	-Fixing kit- Befestigungsset- Moyens de fixation- Materiale di fissaggio- Kit de fijación		1	
QPUP 06x60	Bolt -Schloss-schraube -Boulon- Bullone- Perno- M6x60mm PUP0		12	
QULSy damik 30/40	Cylinder- Zylinderschloss- Serrure a mortaiser- Serratura a cilindro- Bombin- 30.40		1	
QULKaf eHOBEk	Door fittings- Türbeschlag- Ferrure- Ferramenta porta- Manilla puerta- QULKateHOBEk		1	
QULli nkHOBE	Door fittings- Türbeschlag- Ferrure- Ferramenta porta- Manilla puerta- QULlinkHOBE		1	
QTH2 00kZn	Door hinge- Türbänder- Charniere de porte- Cerniere porta- Bisagra de puerta- QTH200kZn		6	
Qtaba kramp 35x100	Hasp- Haspe- Porte-cadenas- Portaluchetto- Amella para candado- 100x35x2.5kZn		8	
QR30100 nurkkZn	Hook- Haken- Crochet- Ganzio- Pestillo QR30100nurkkZn		4	
QNU4 04040	L-iron- Winkel- Angle -Angolo- Angulo 40x40x40		2	
QMU6	Nut- Schraubenmutter- Écrou- Dado- Tuerca- M6mm		12	
QKR3 5x40Zn	Screw- Schraube- Vis- Vite- Tornillo- 3.5x40mm		80	
QKR3x 16kZn	Screw- Schraube- Vis- Vite- Tornillo- 3x16mm kZn		32	
QKR3 x30Zn	Screw- Schraube- Vis- Vite- Tornillo- 3x30mm		10	
QKR4 5x50Zn	Screw- Schraube- Vis- Vite- Tornillo- 4.5x50mm		26	
QKR4 5x60Zn	Screw- Schraube- Vis- Vite- Tornillo- 4.5x60mm		24	
QKR4 5x70Zn	Screw- Schraube- Vis- Vite- Tornillo- 4.5x70mm		110	
QKR4x 25kZn	Screw- Schraube- Vis- Vite- Tornillo- 4x25mm kZn		84	
QKR5 x90Zn	Screw- Schraube- Vis- Vite- Tornillo- 5x90mm		18	
QKR6x 120Zn	Screw- Schraube- Vis- Vite- Tornillo- 6x120mm		46	
QKarab iinkon ks4x40	Snap hook- Karabiner- Mousqueton- Moschettone- Mosquetón KH40 4x40		4	
QSE6x18	Washer- Dichtscheibe- Joint- Rondella- Arandela- 6x18mm		12	
	Object name "ELD16-2719"		Page 3/3	



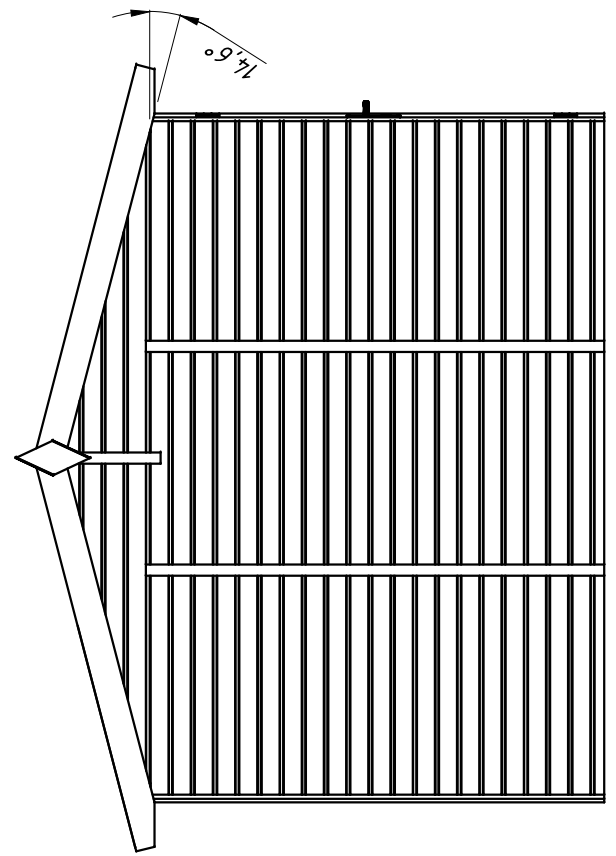
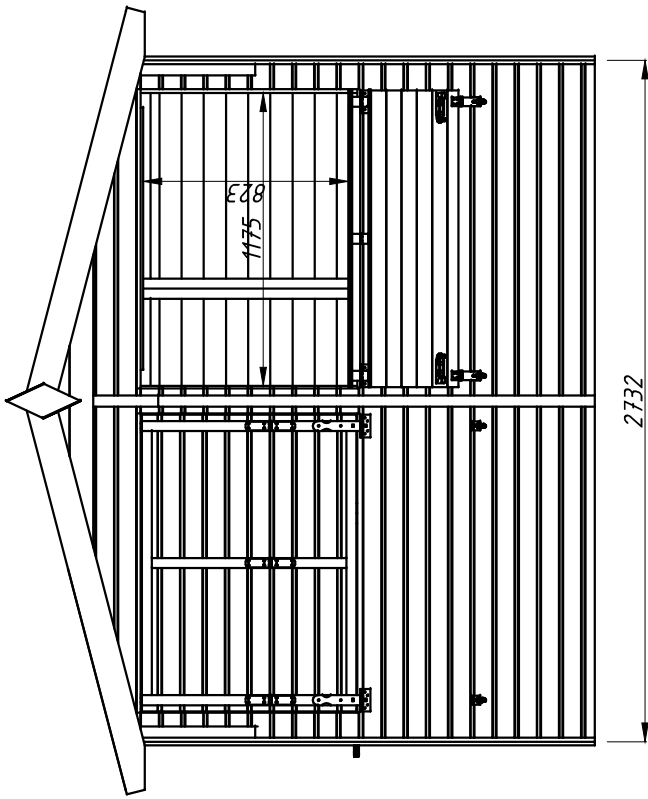
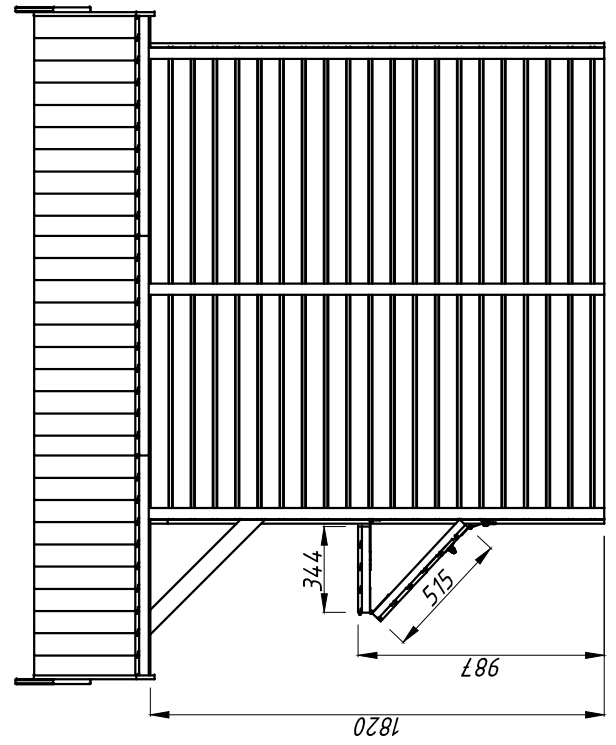
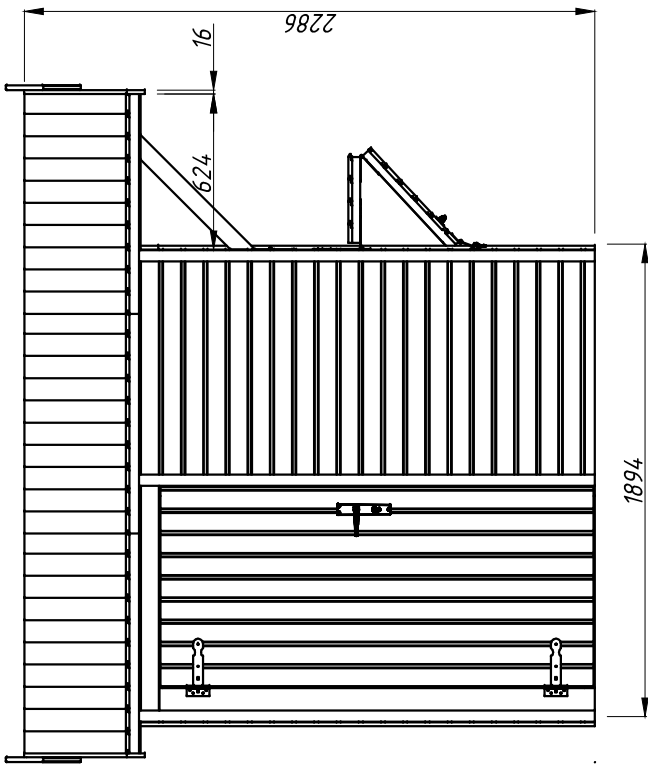

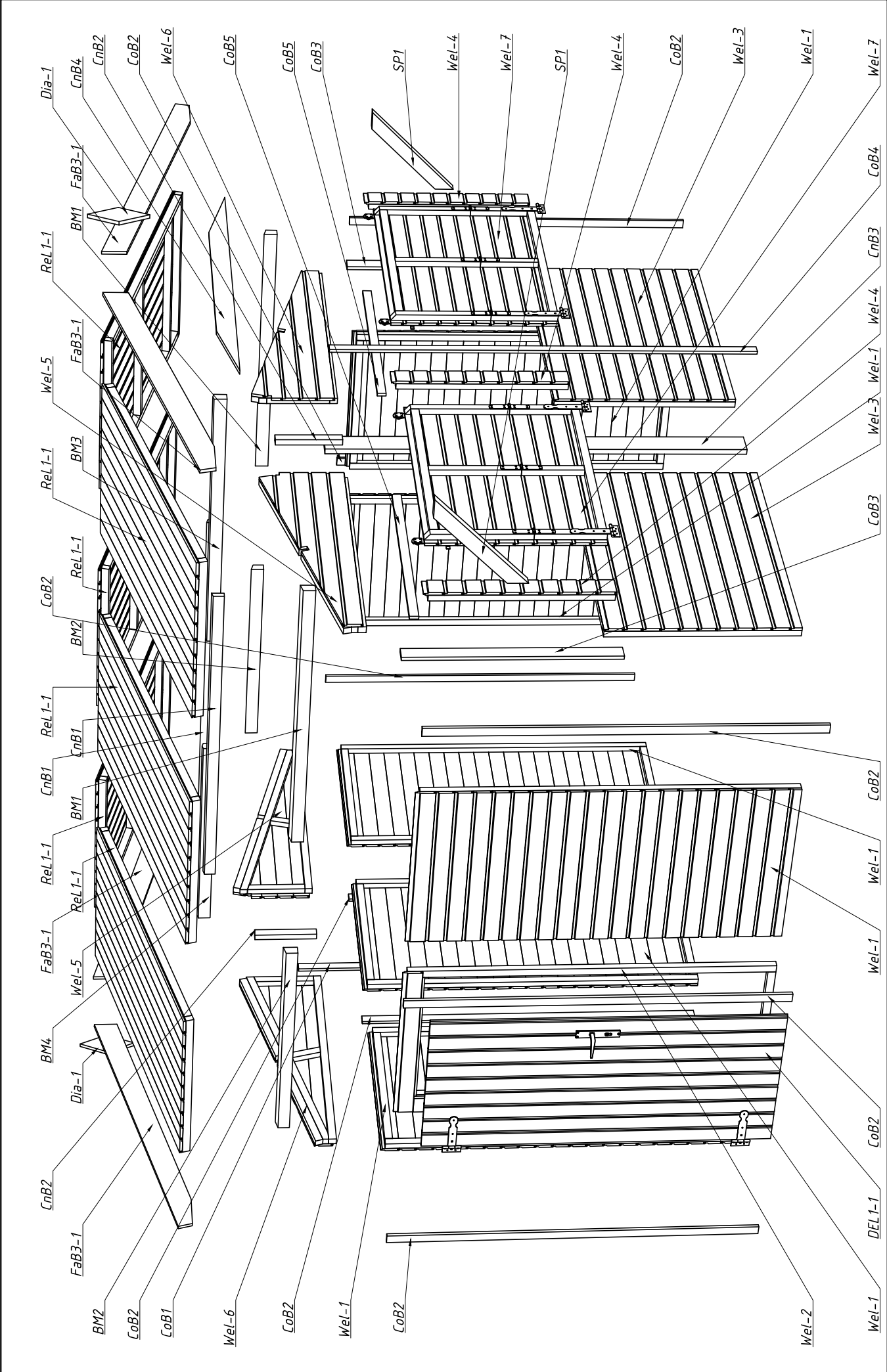

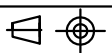
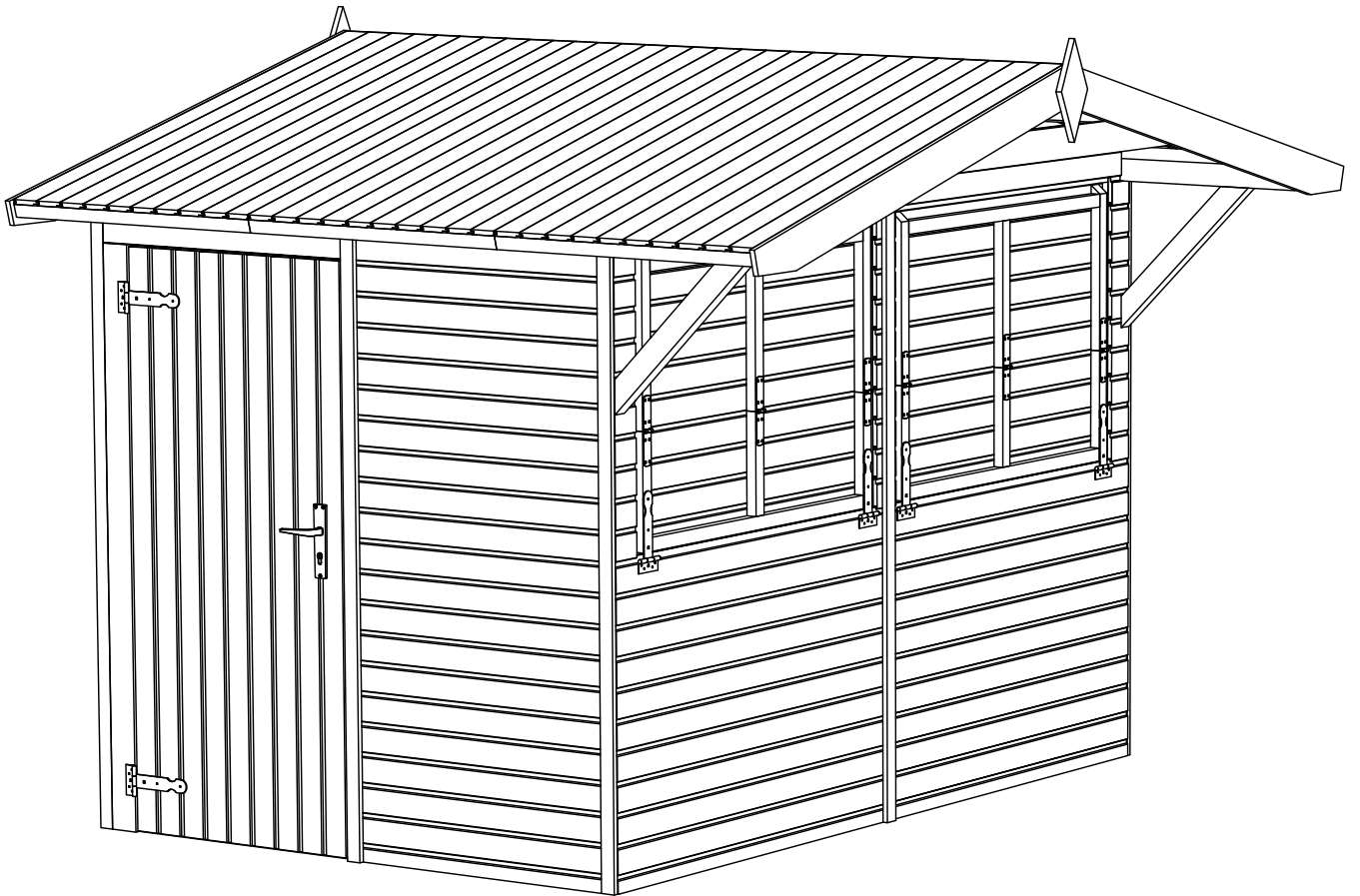

Wel-1 2 pcs  
4,5x70 5 pcs

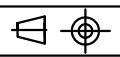
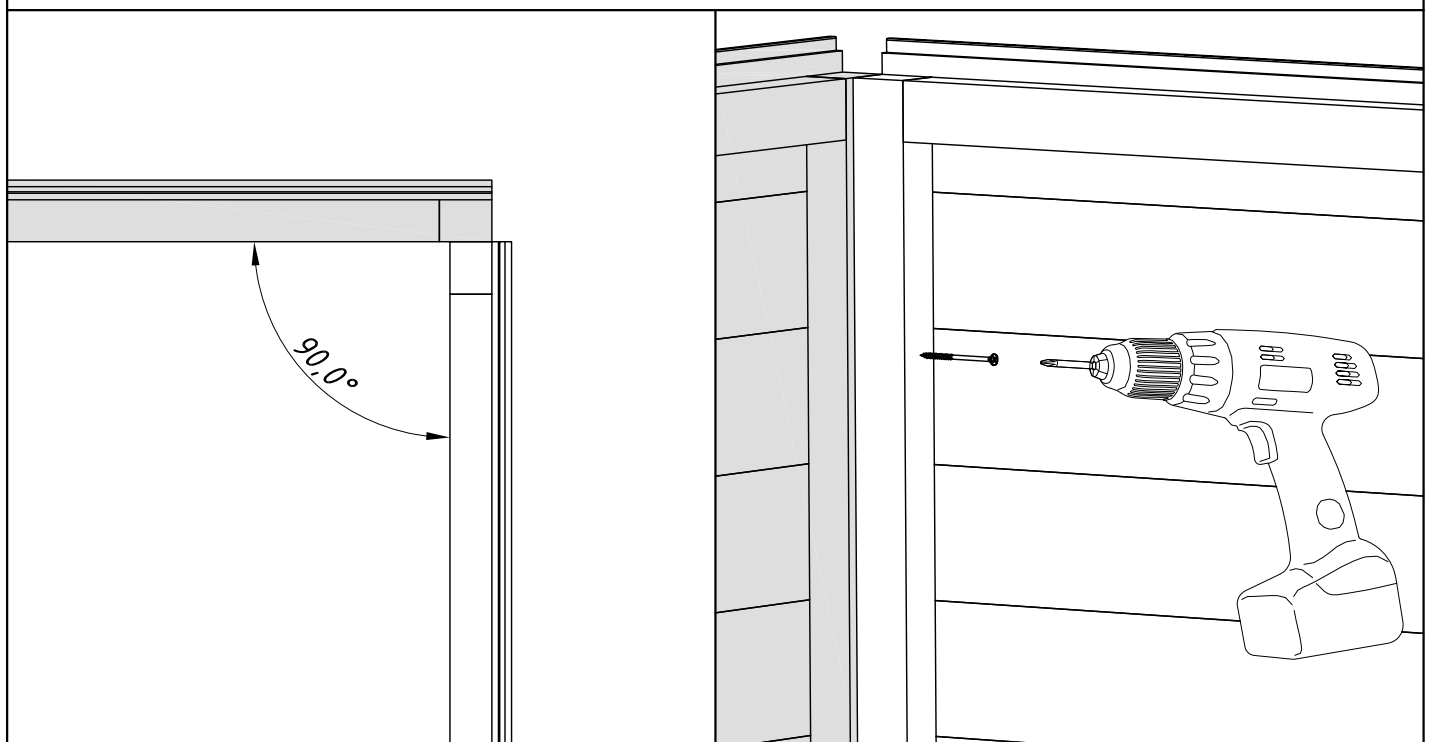
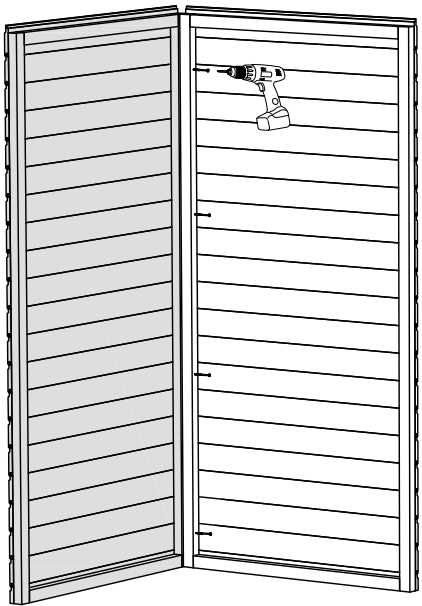
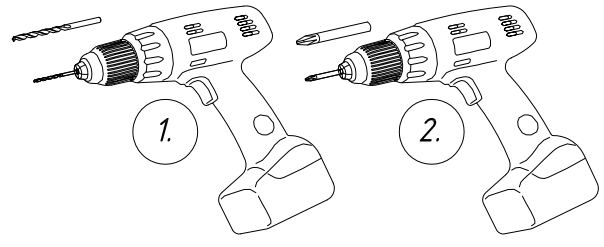

Wel-1      4      pcs  
 Wel-2      1      pcs  
 4,5x70    25      pcs

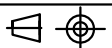
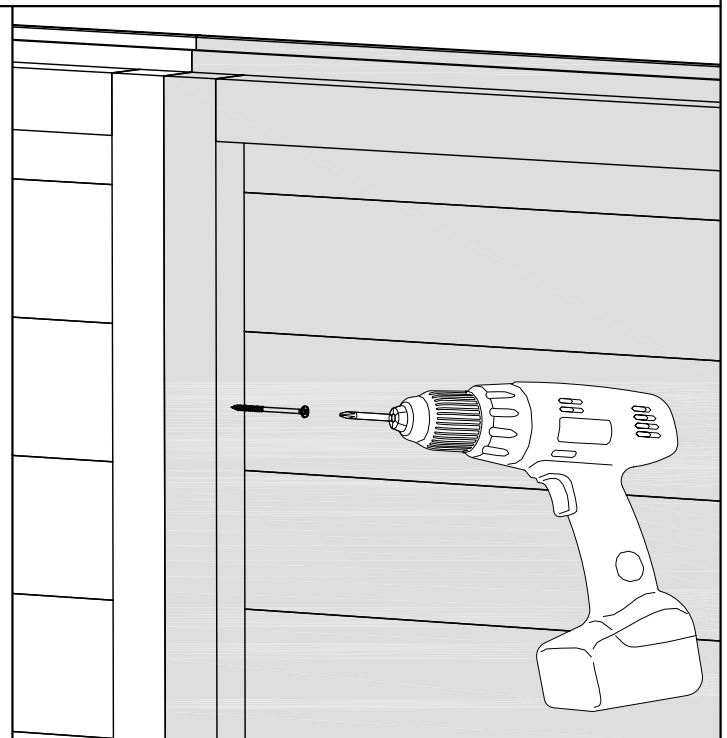
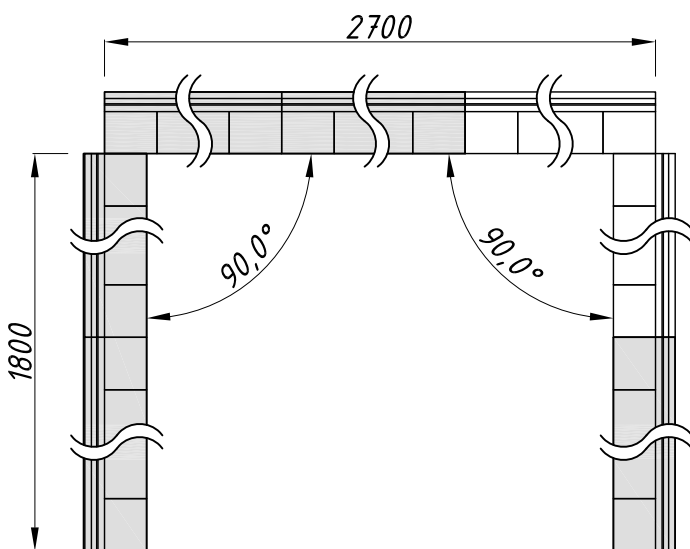
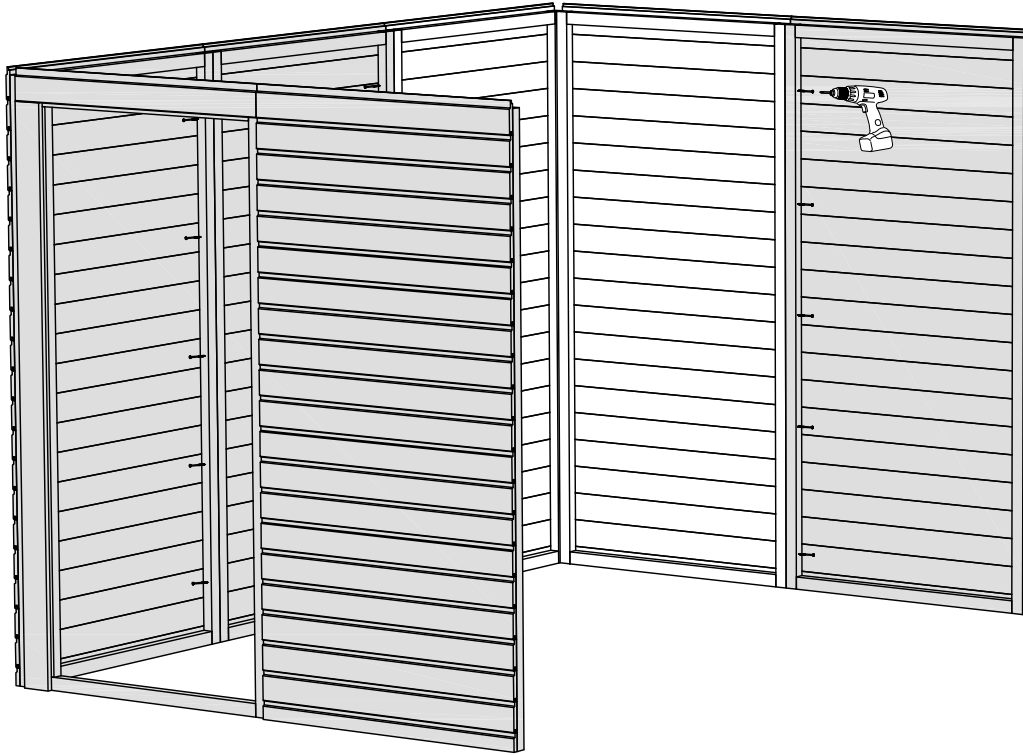
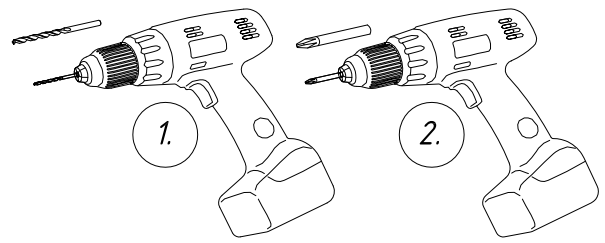

- Wel-3        2        pcs
- Wel-4        3        pcs
- CnB3         1        pcs
- 4,5X60      12      pcs
- 4,5x70      15      pcs

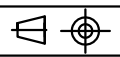
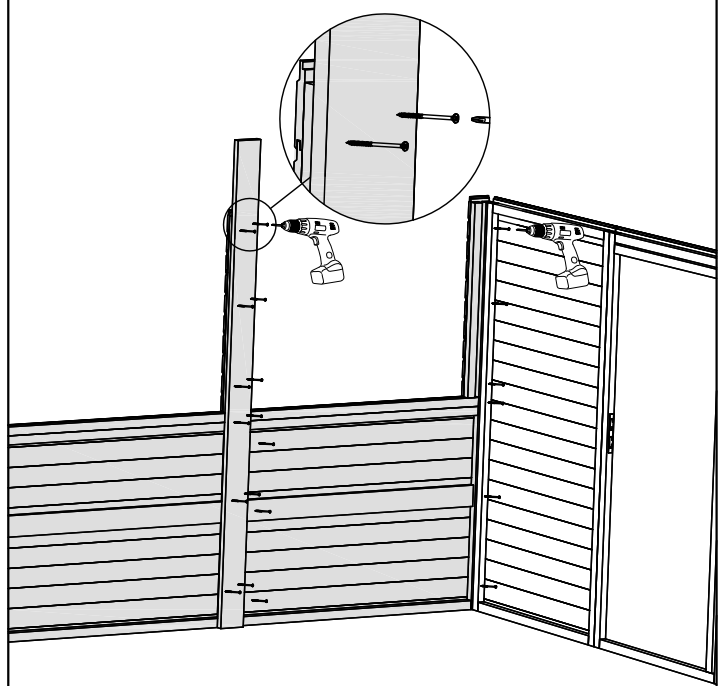
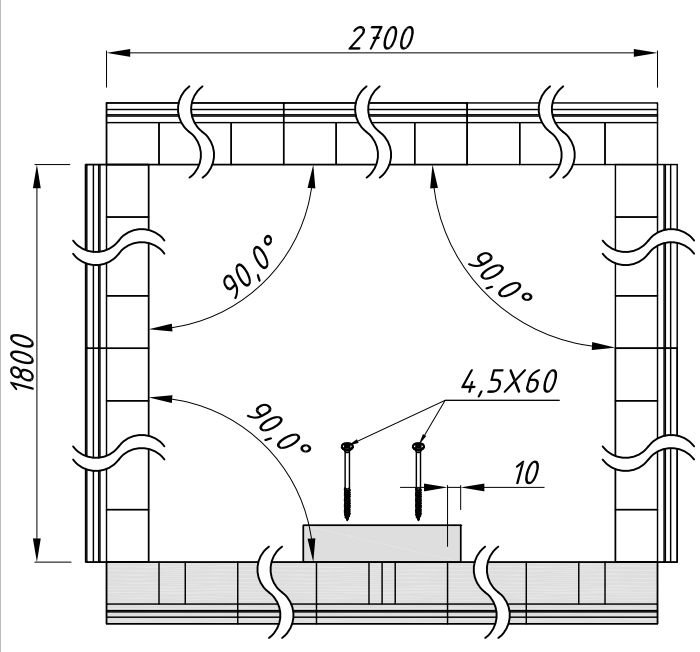
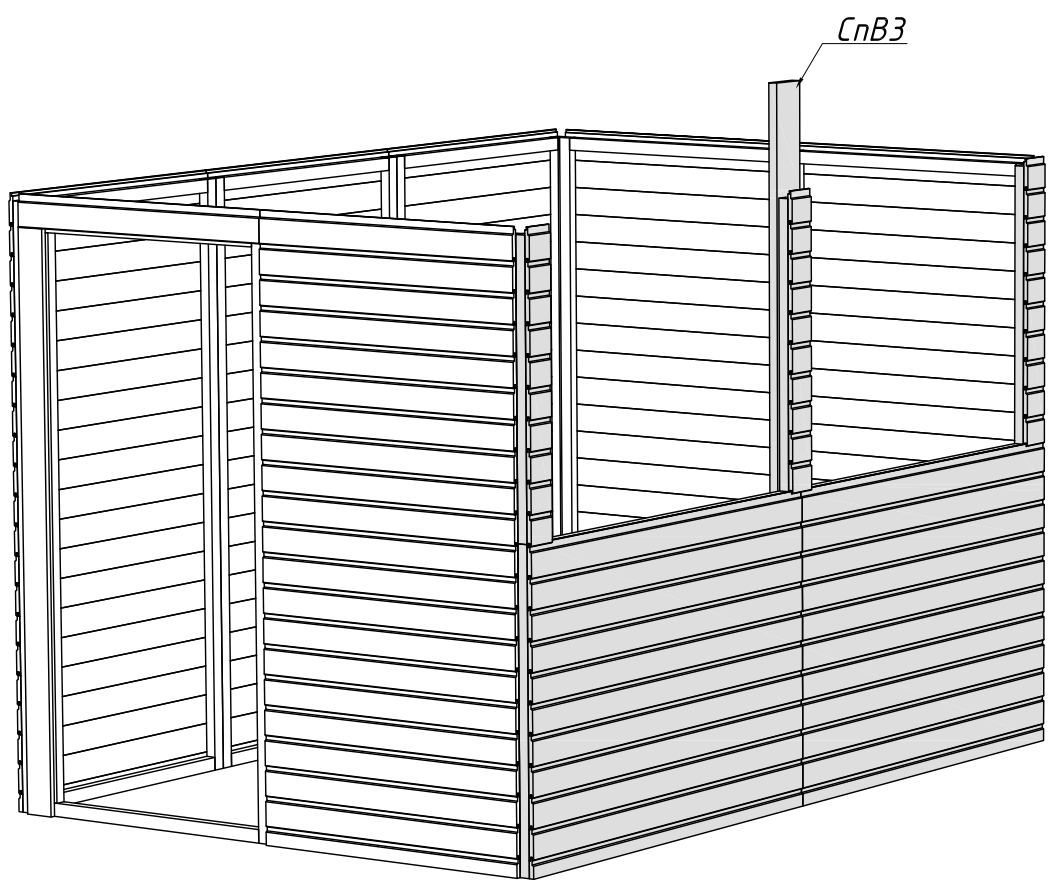
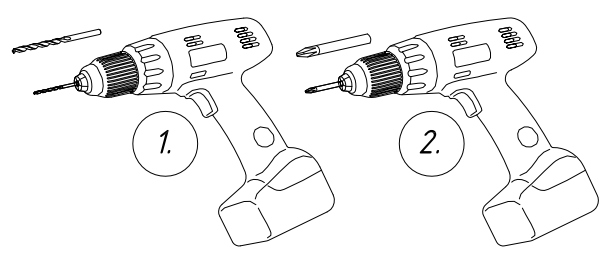

- Wel-5      1      pcs
- Wel-6      1      pcs
- CnB2       2      pcs
- 4,5X50    2      pcs
- 4,5x70    12     pcs

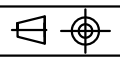
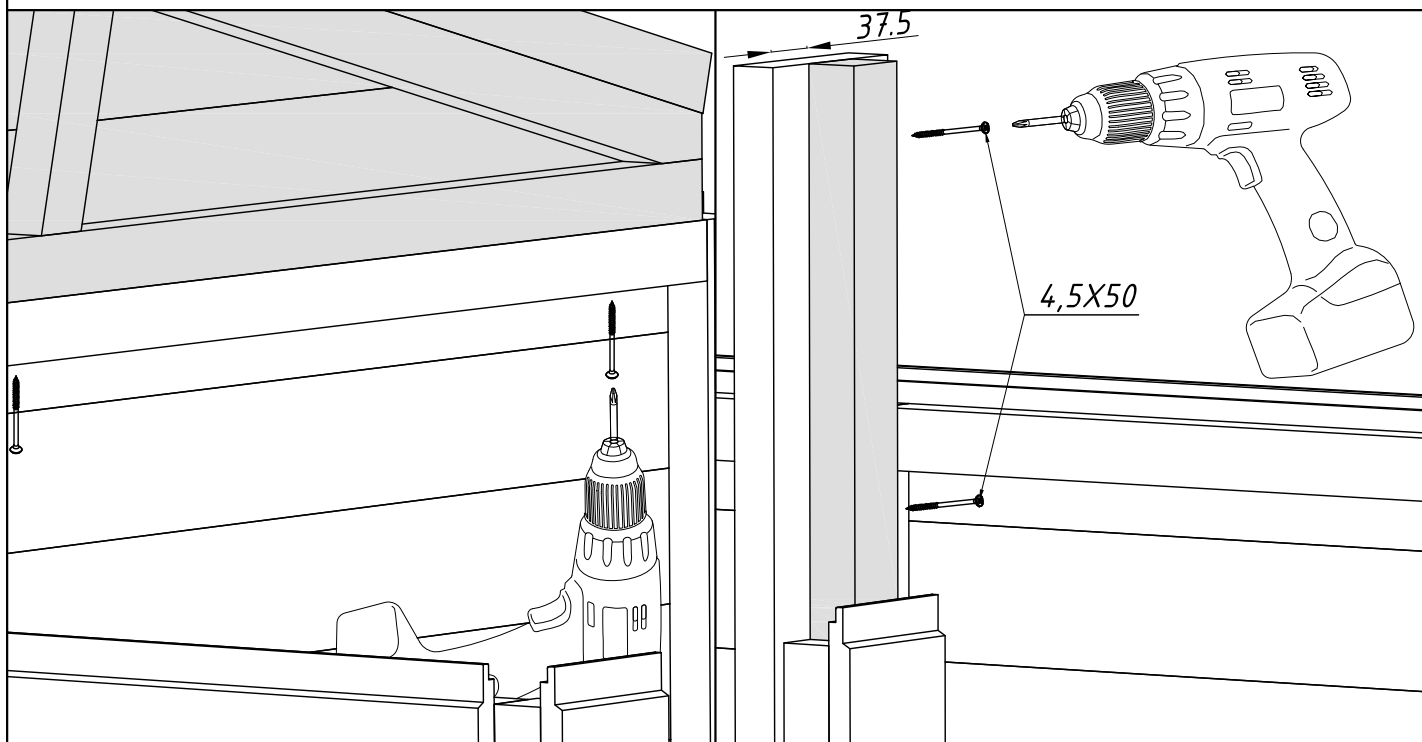
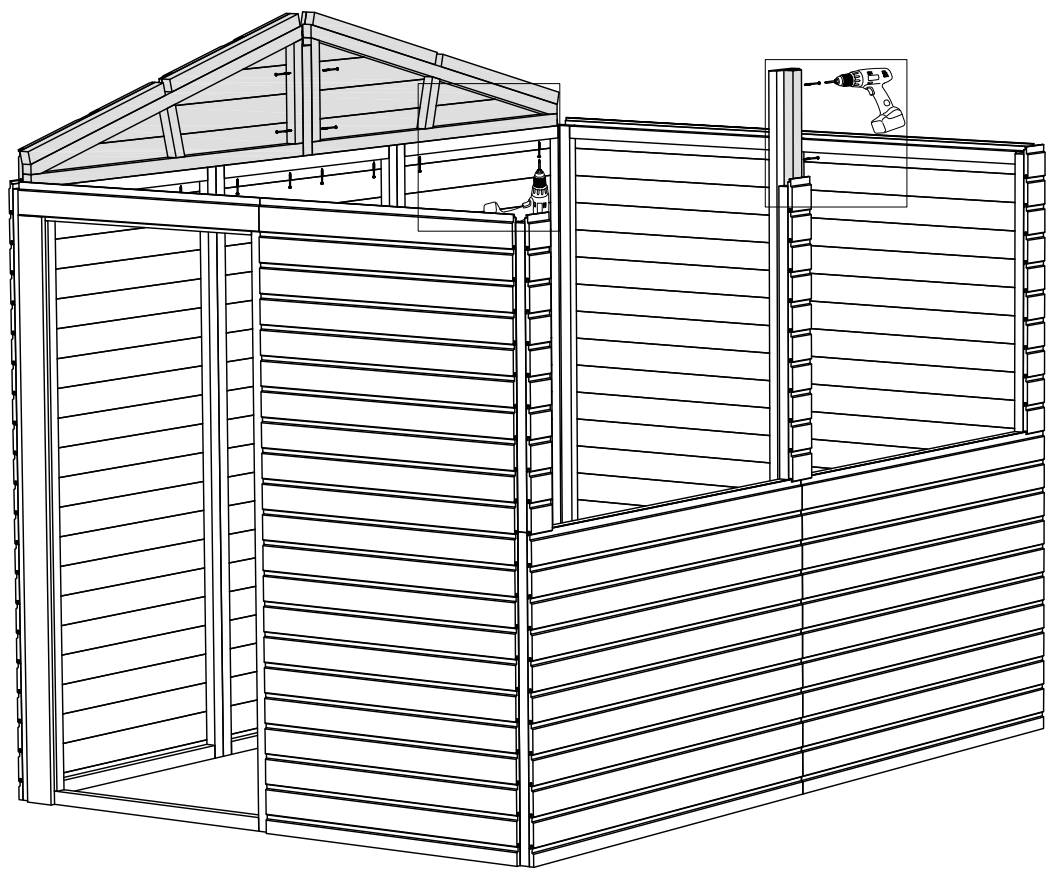
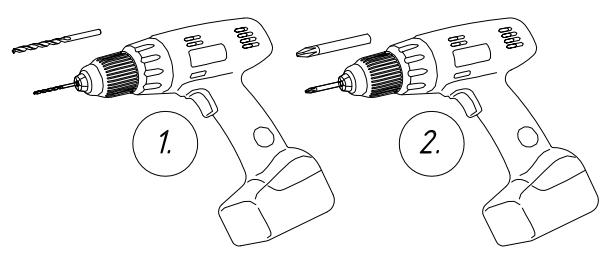

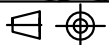
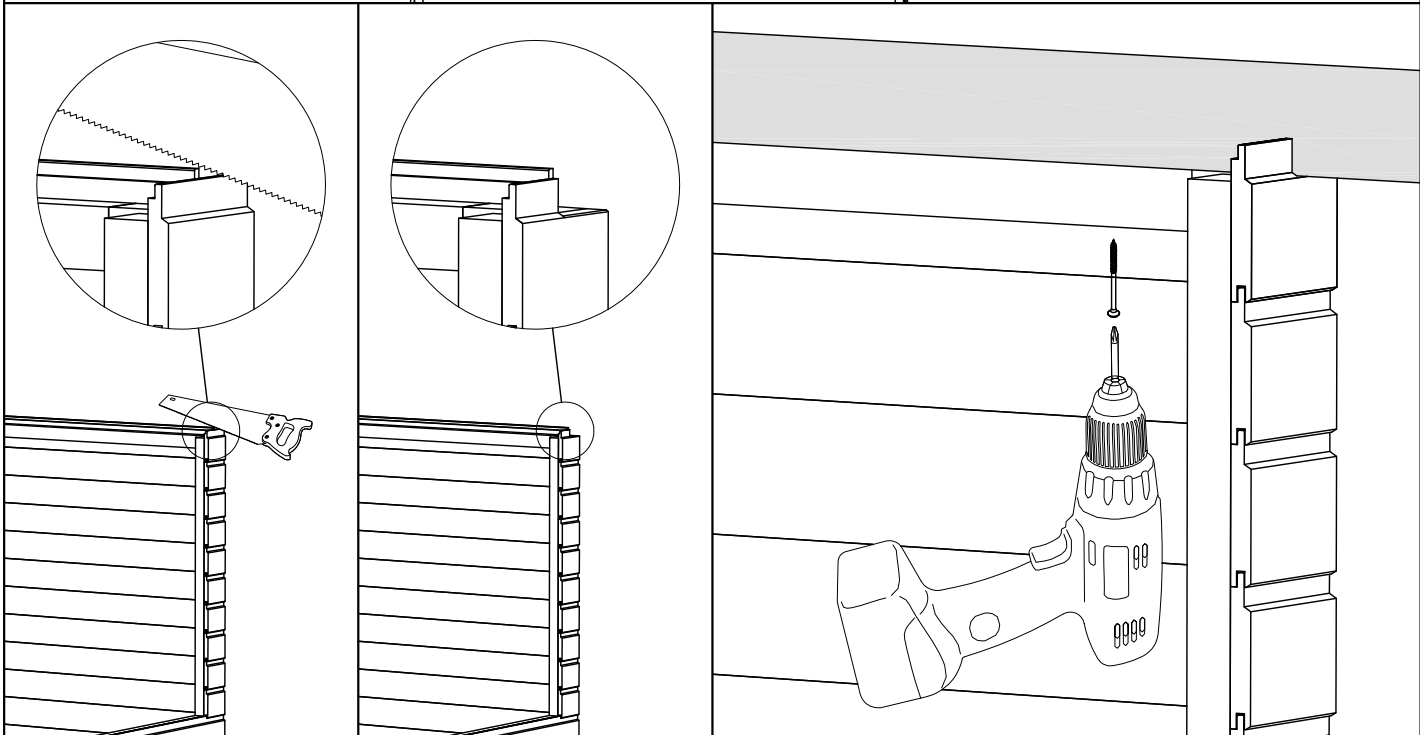
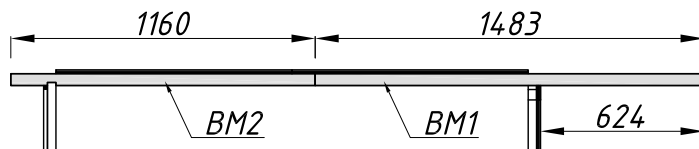
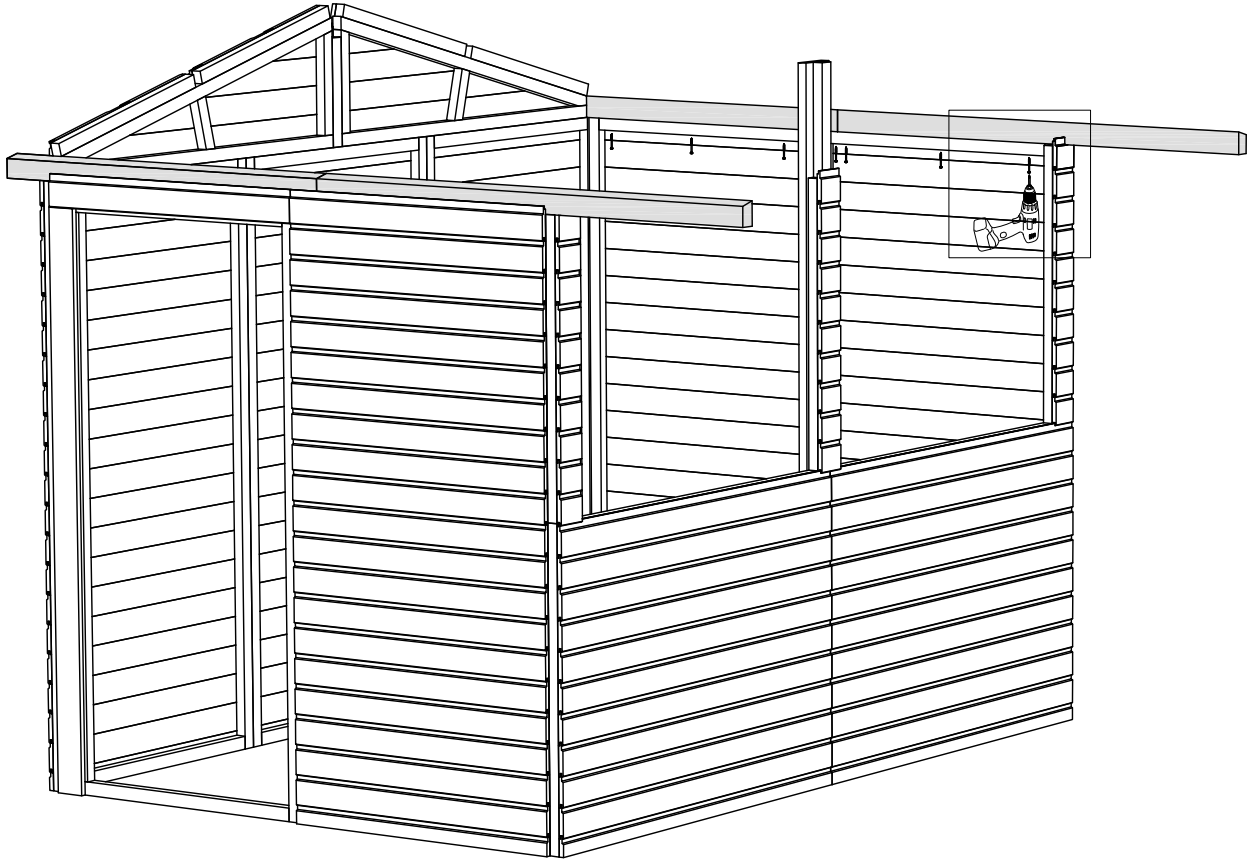
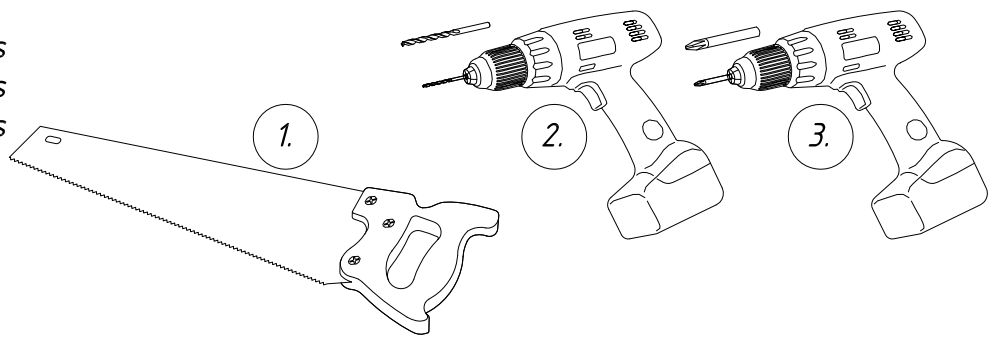

BM1 2 pcs  
 BM2 2 pcs  
 5X90 14 pcs





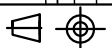
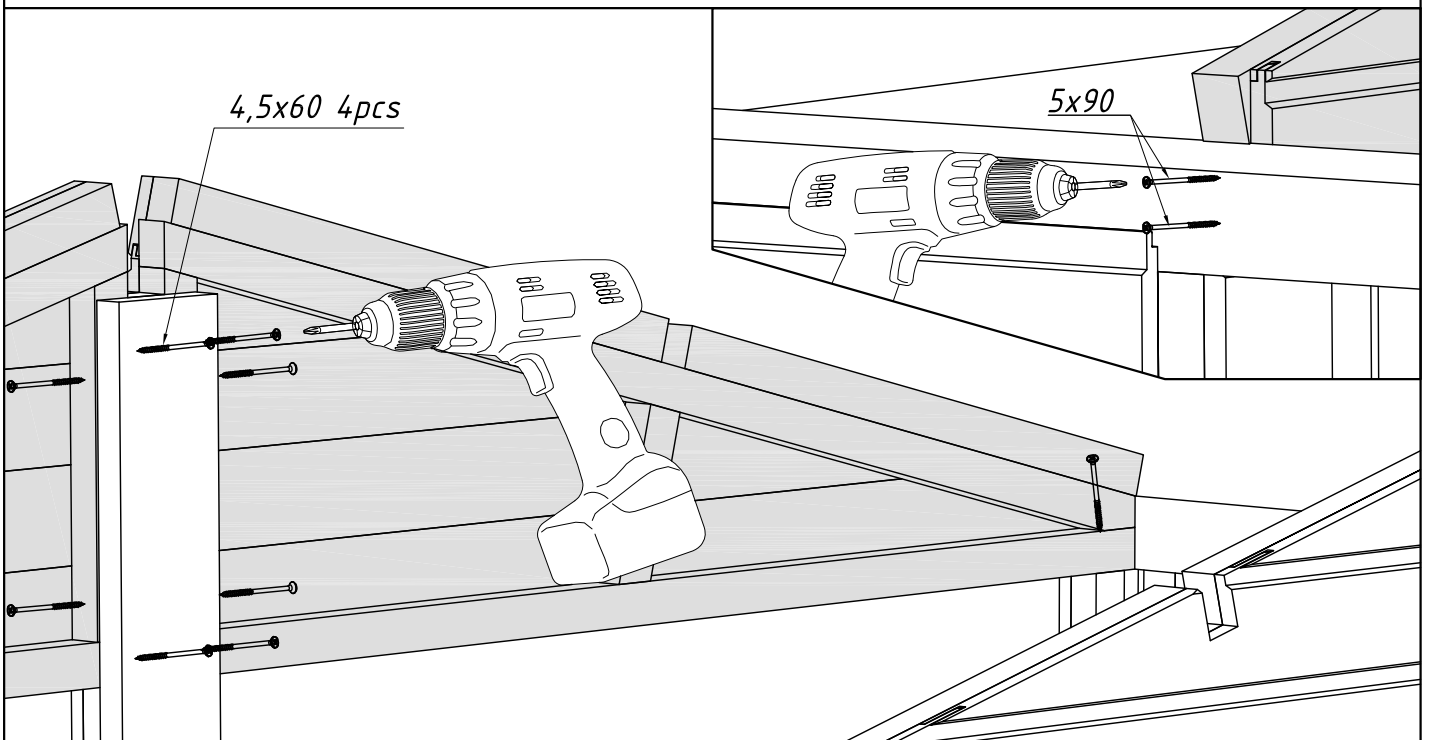
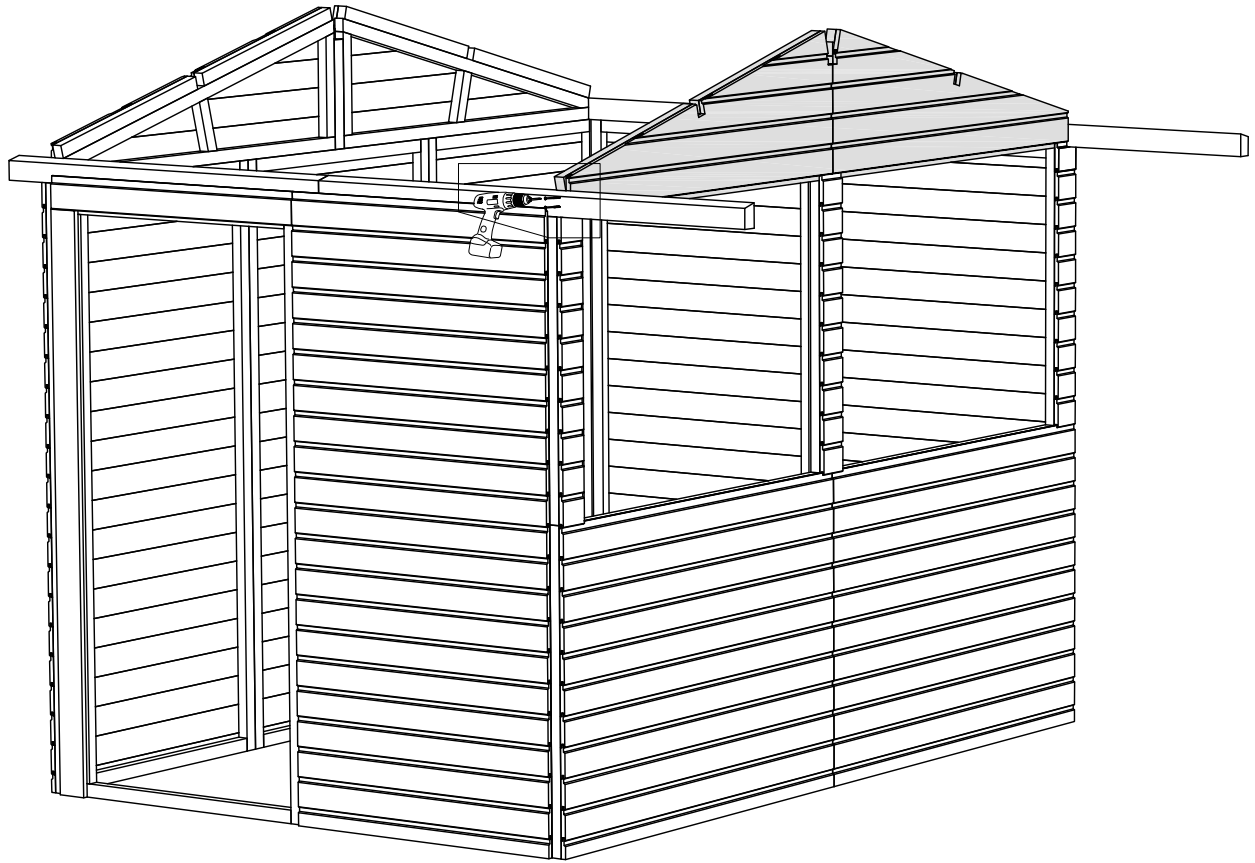
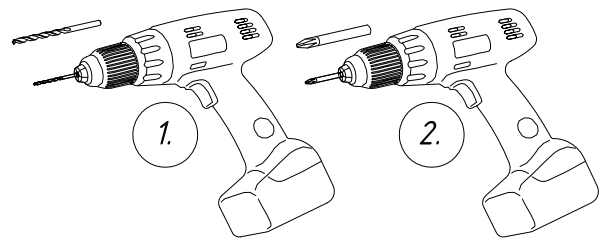



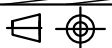
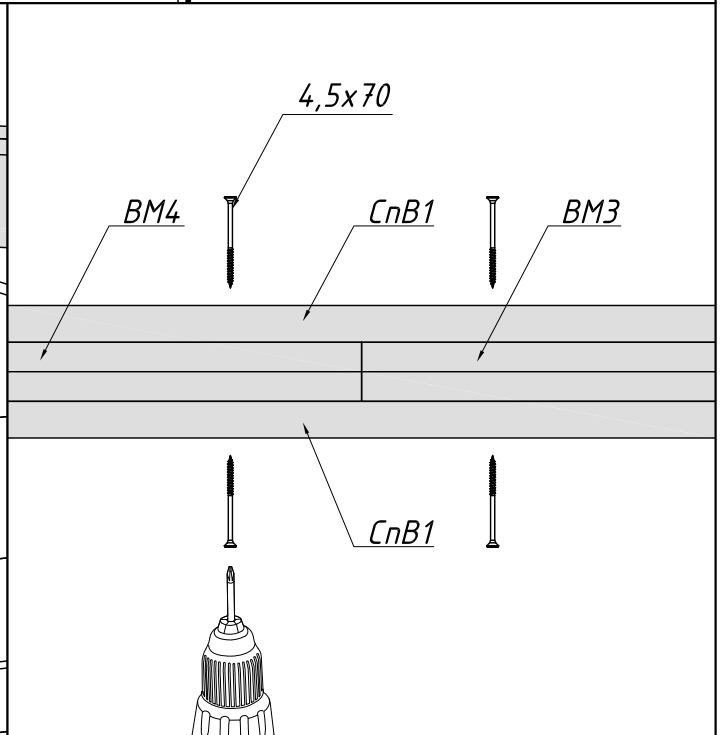
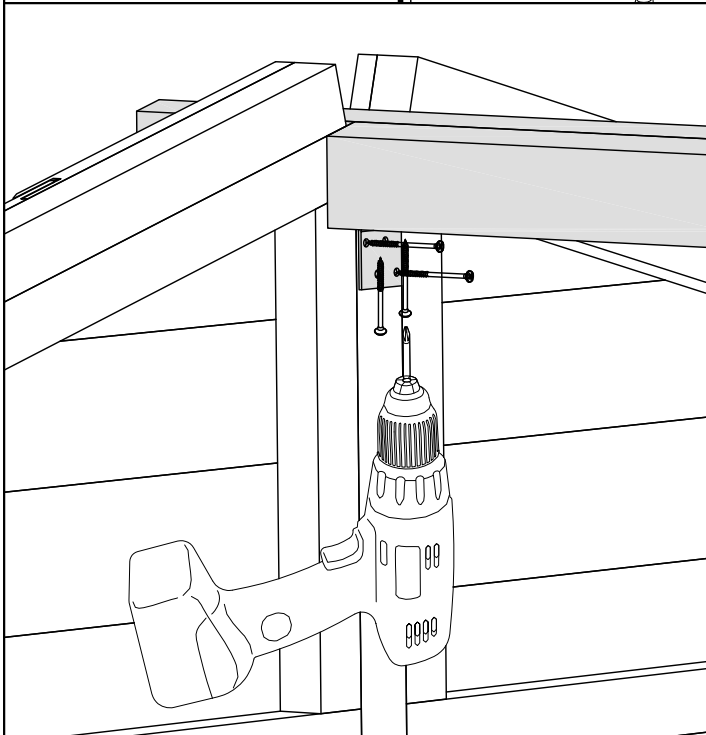
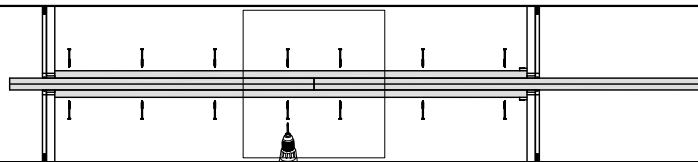
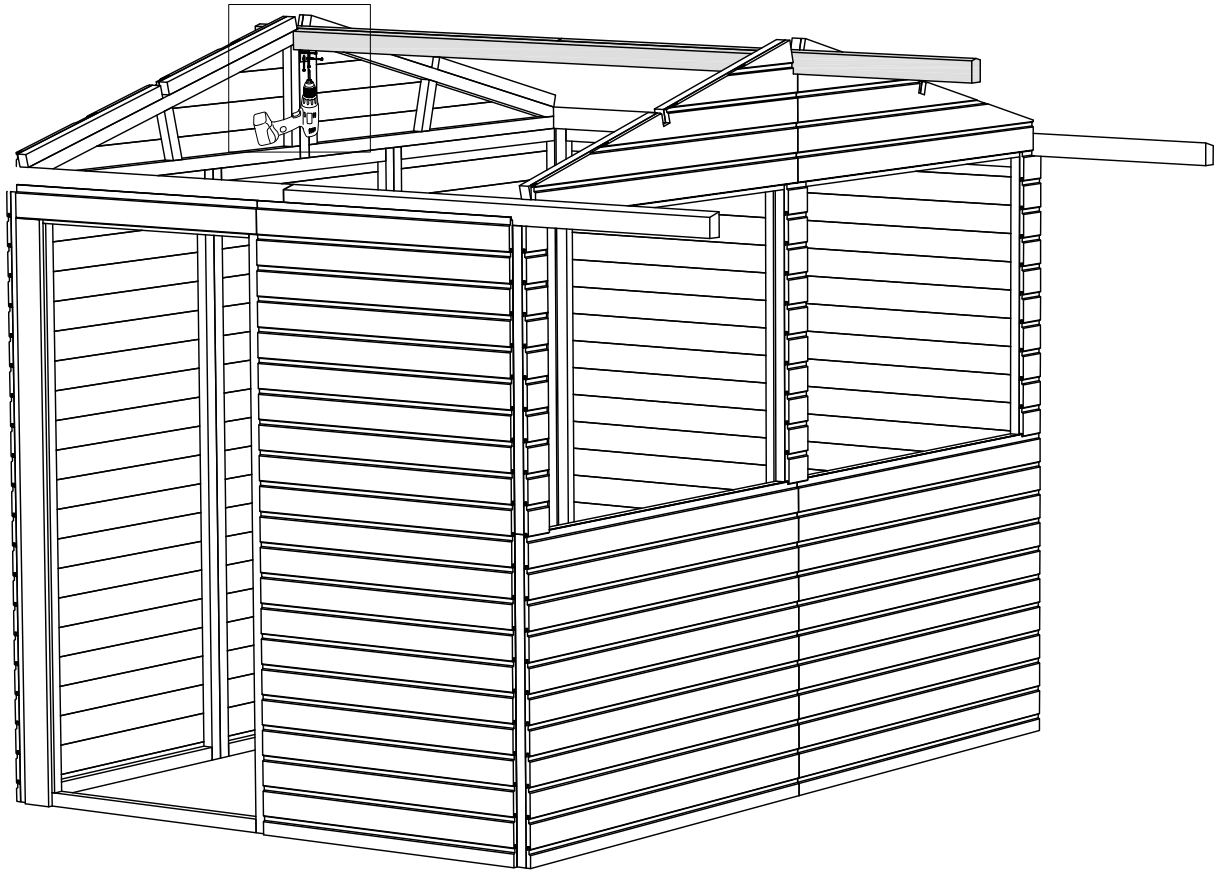
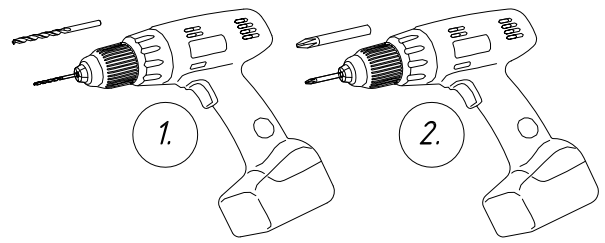

- Wel-5 1 pcs
- Wel-6 1 pcs
- 4,5X60 4 pcs
- 4,5x70 10 pcs
- 5x90 4 pcs



BM3	1	pcs
BM4	1	pcs
CnB1	2	pcs
4,5x60	8	pcs
4,5x70	20	pcs
	2	pcs

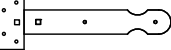

- DEL1-1      1      pcs
- 4x25        12     pcs
-       1      pcs
-         1      pcs
-       1      pcs
-       2      pcs
-       4      pcs

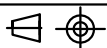
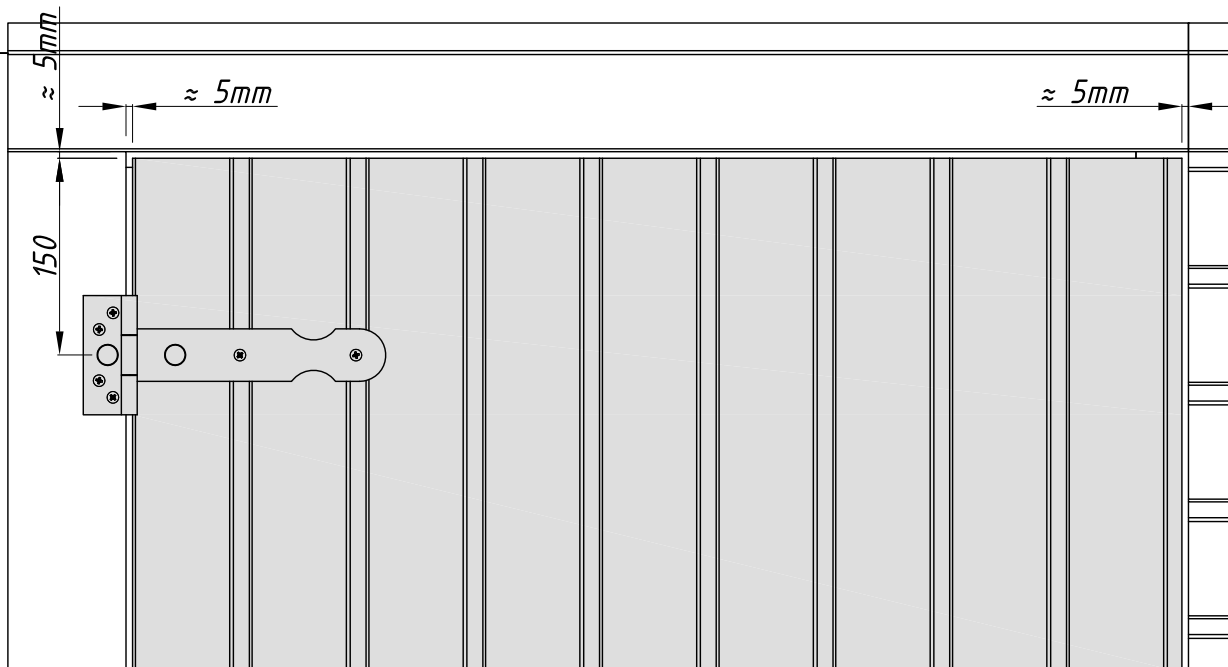
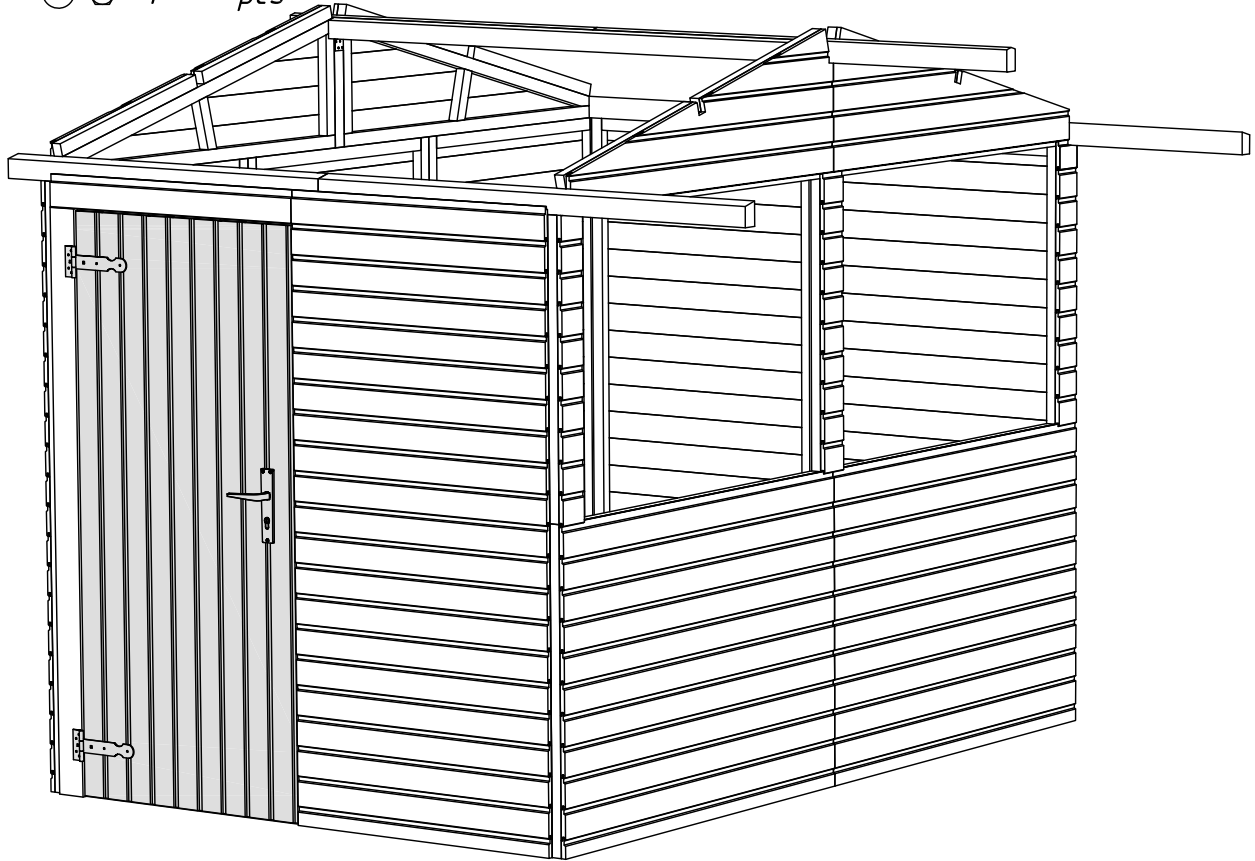
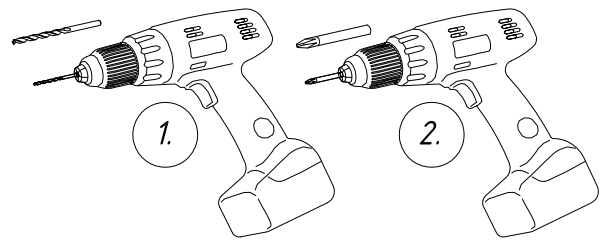

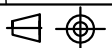
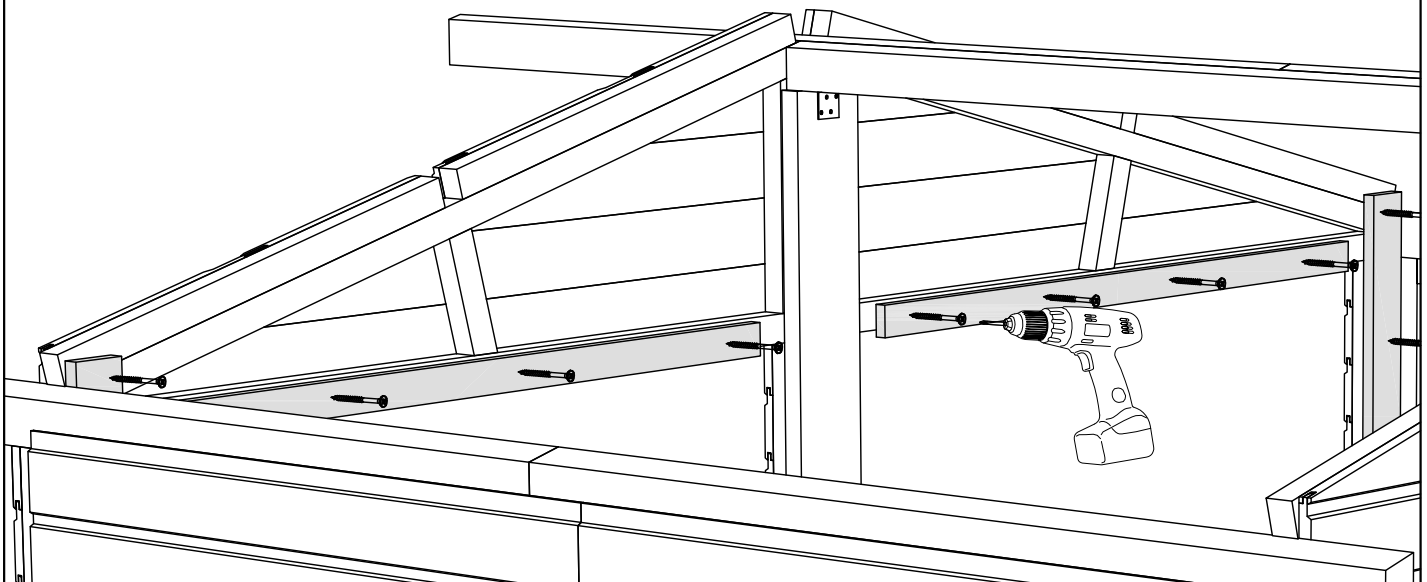
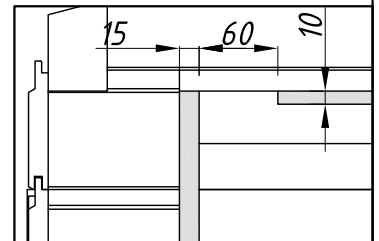
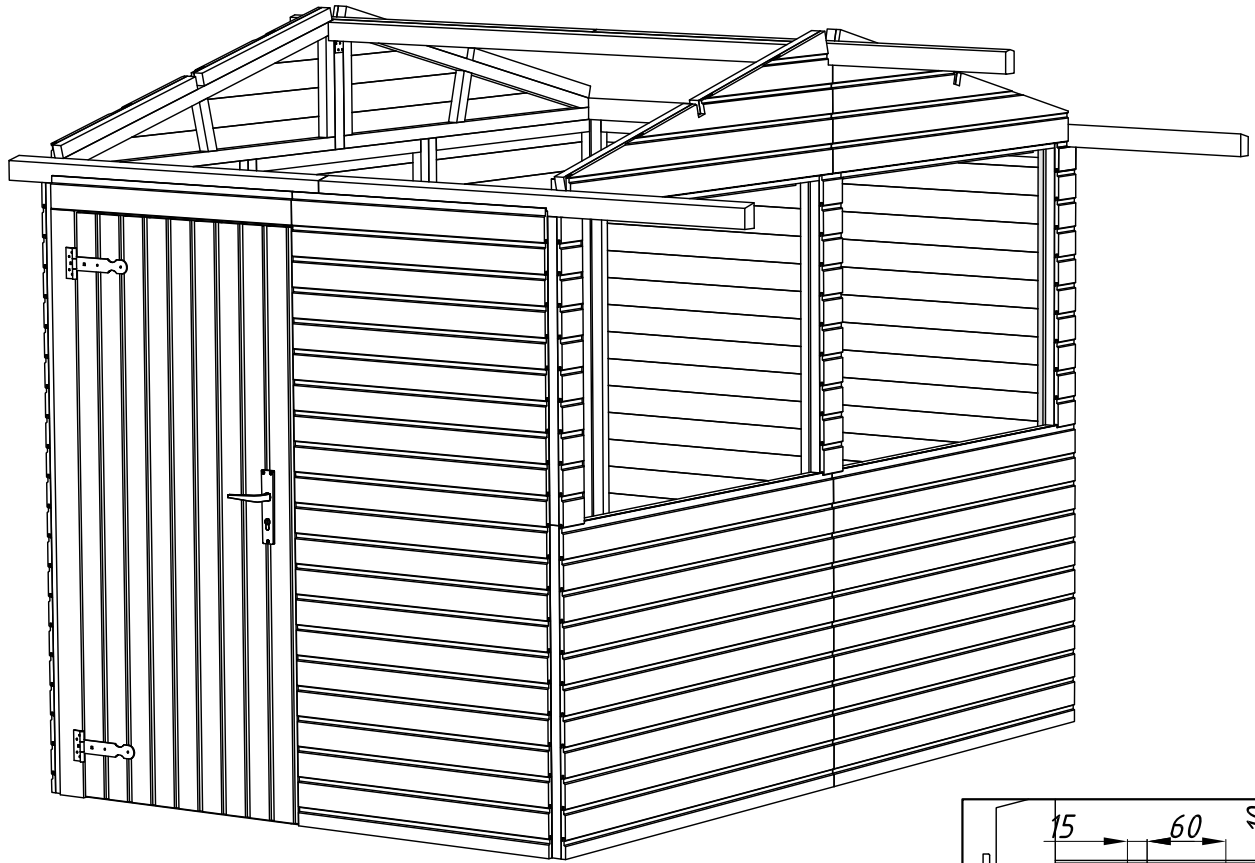
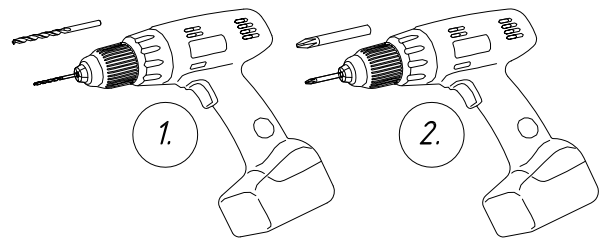

CoB3 2 pcs  
 CoB5 2 pcs  
 4,5X50 16 pcs

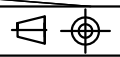
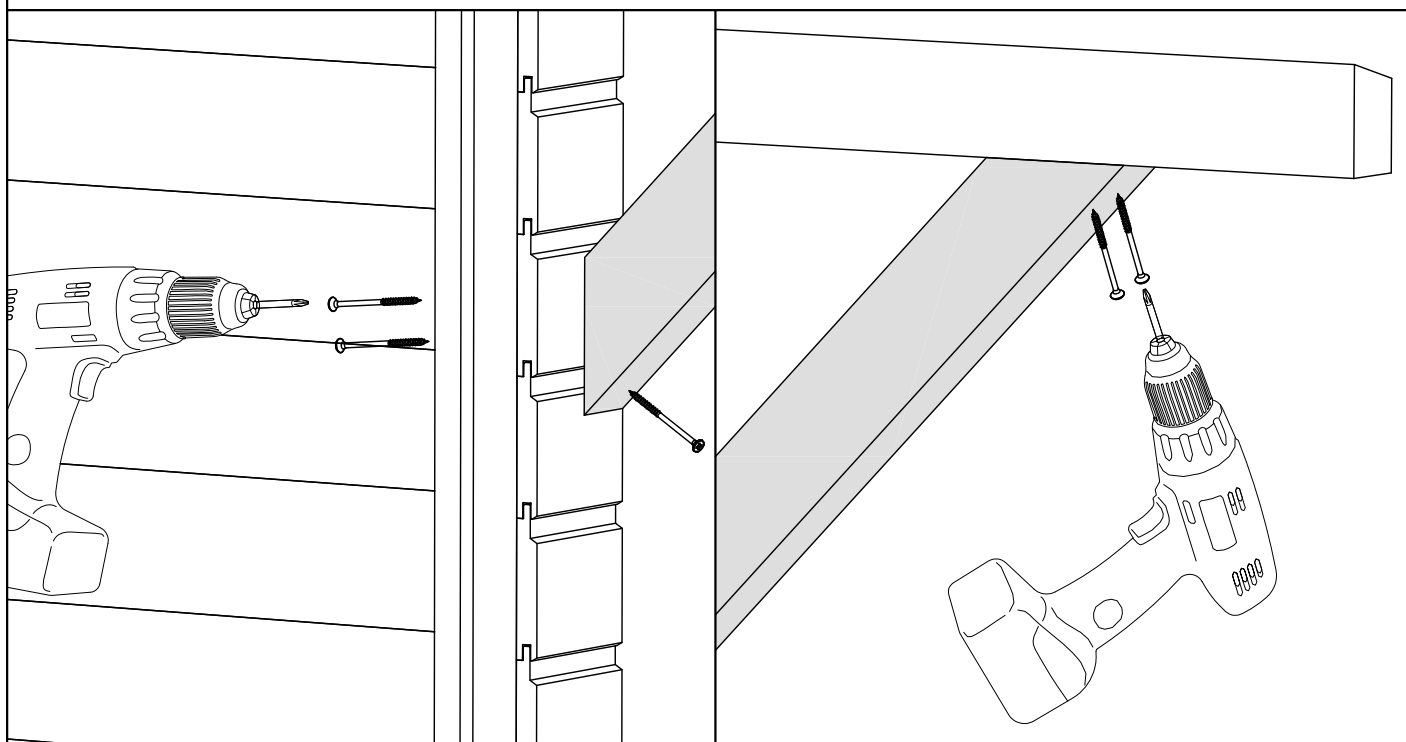
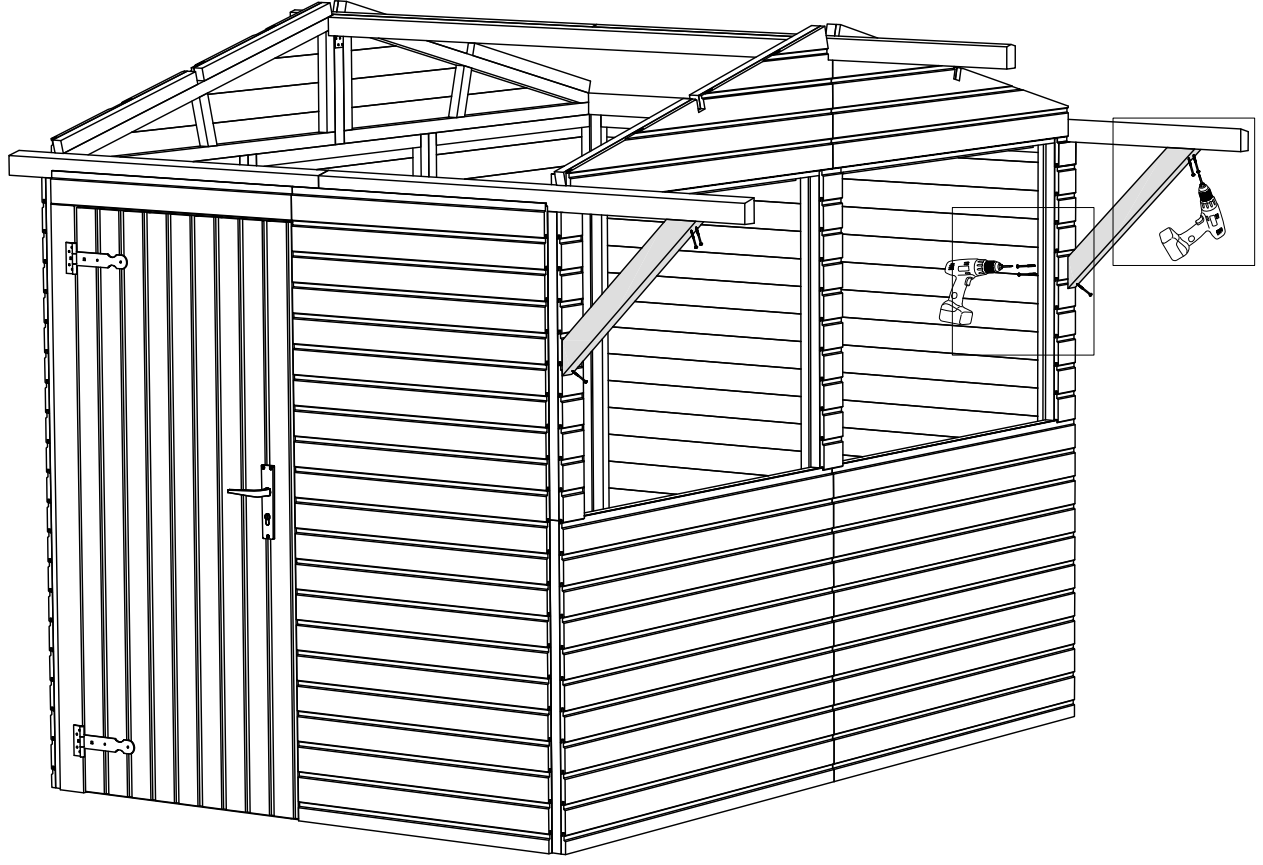
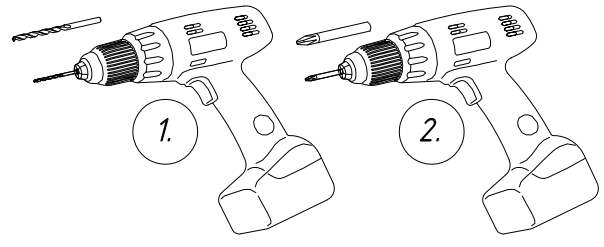

SP1  
6x120

2 pcs  
10 pcs

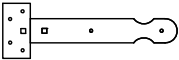

- Wel-7 2 pcs
- 4x25 24 pcs
-  4 pcs
-  8 pcs

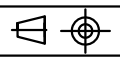
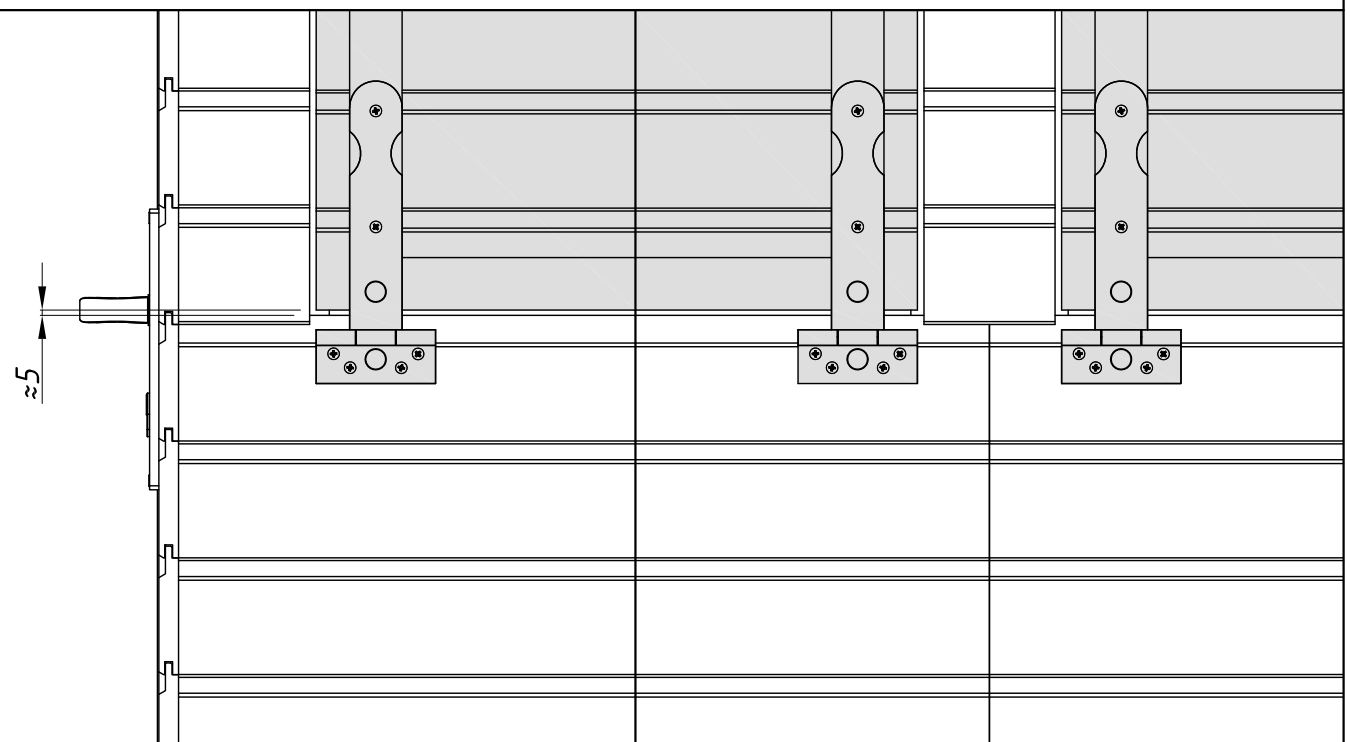
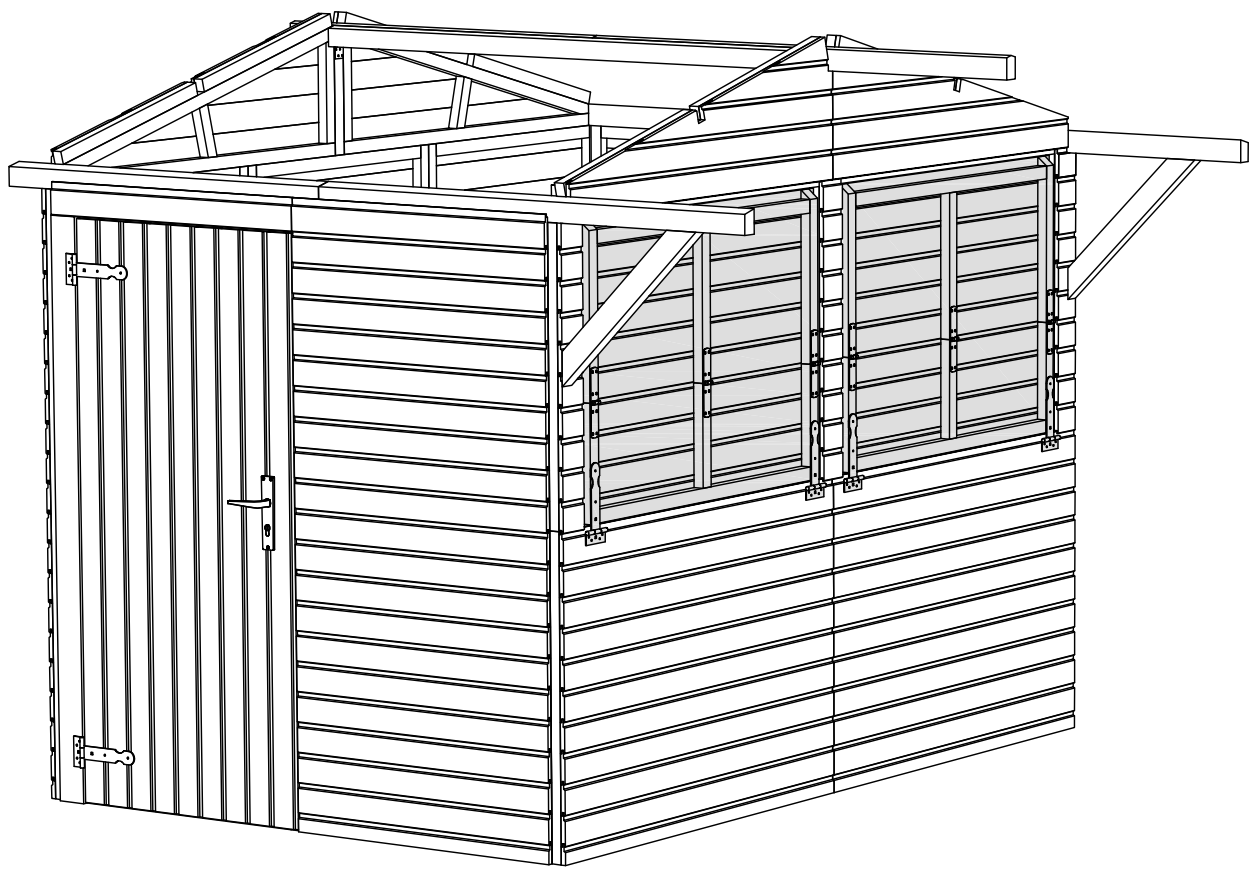
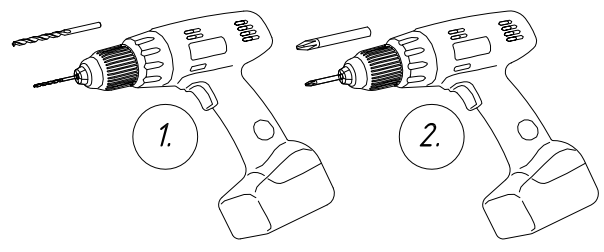

4x25

32 pcs

3x16

32 pcs

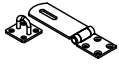



4 pcs

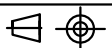
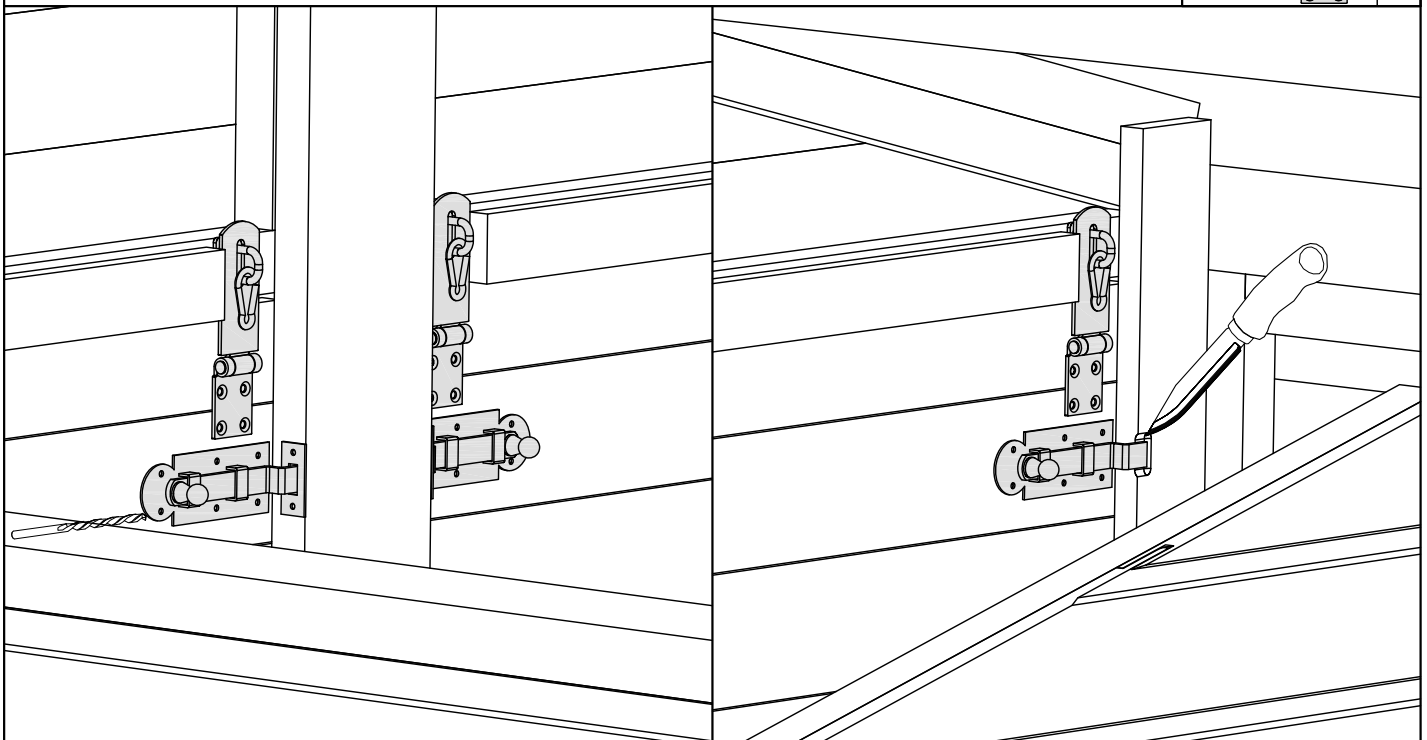
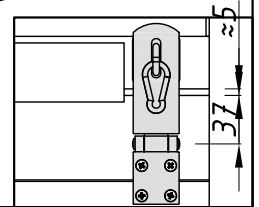
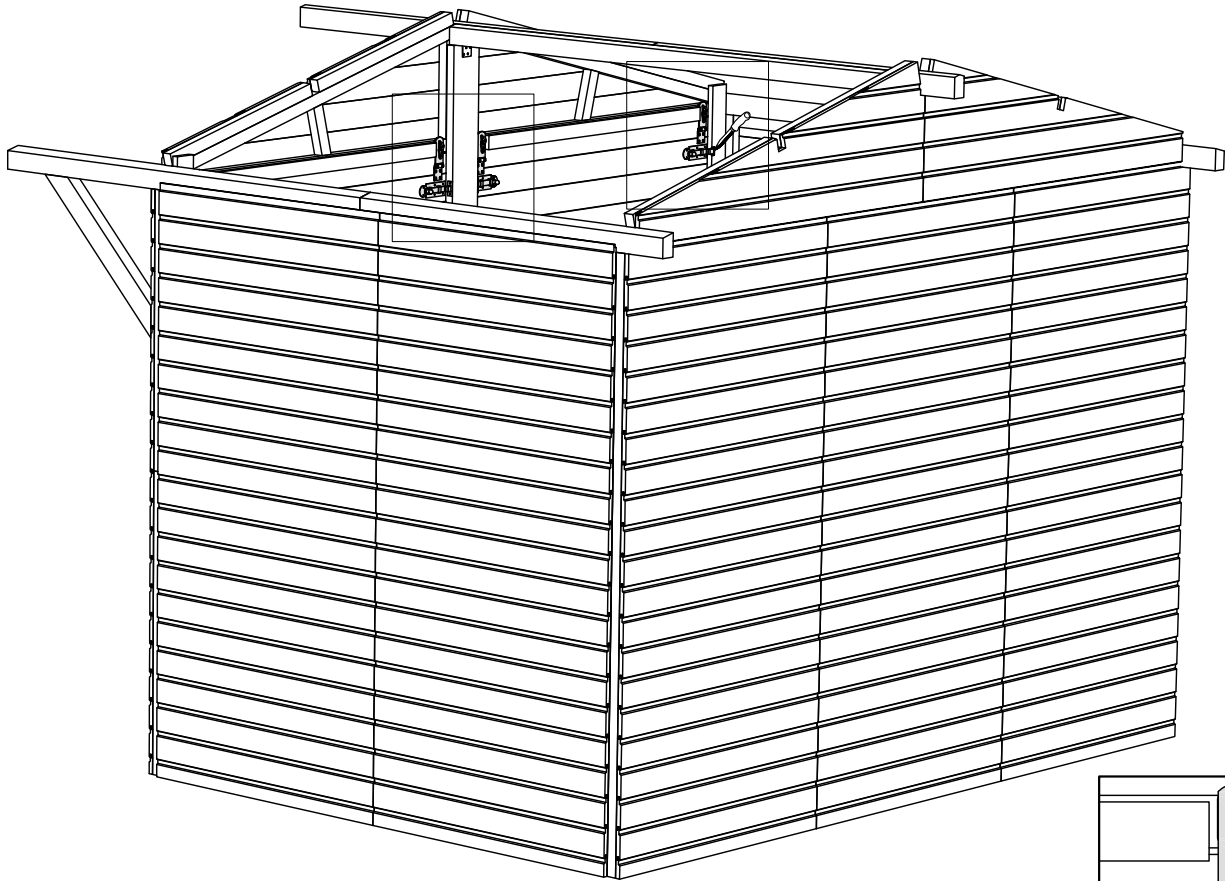
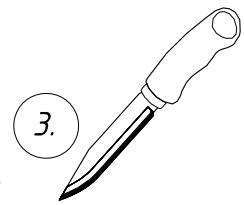
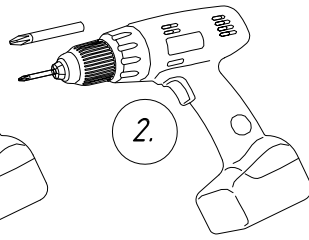
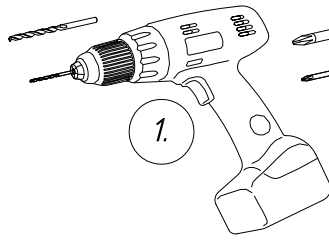

4 pcs



- 4x25      16    pcs
-       4    pcs
-       4    pcs

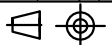
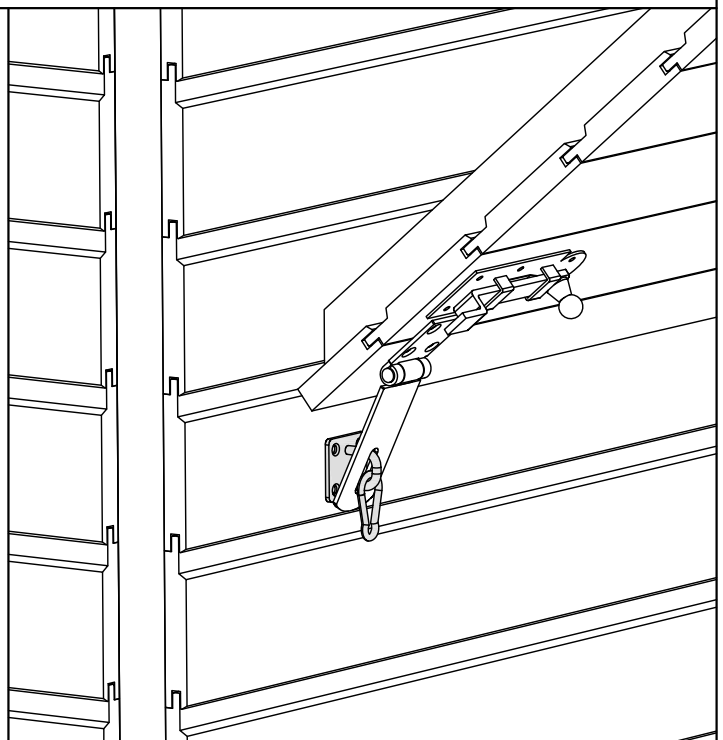
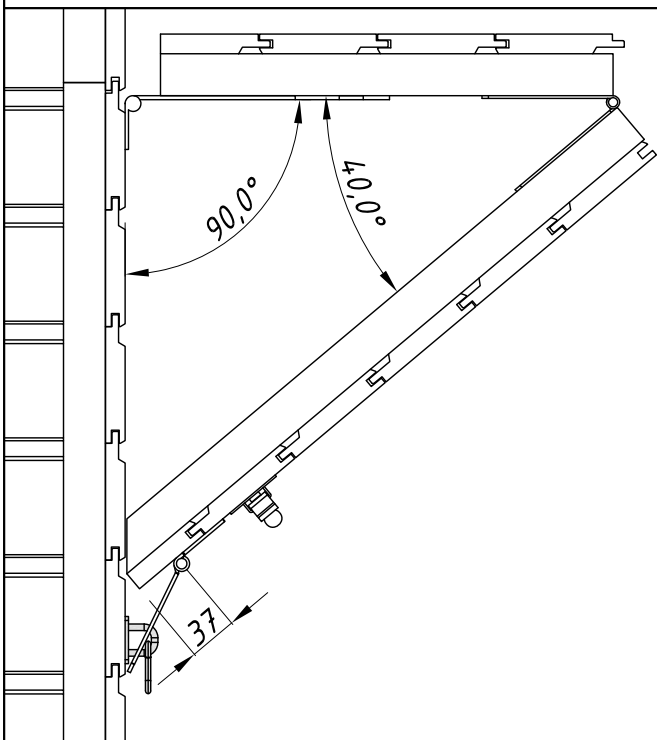
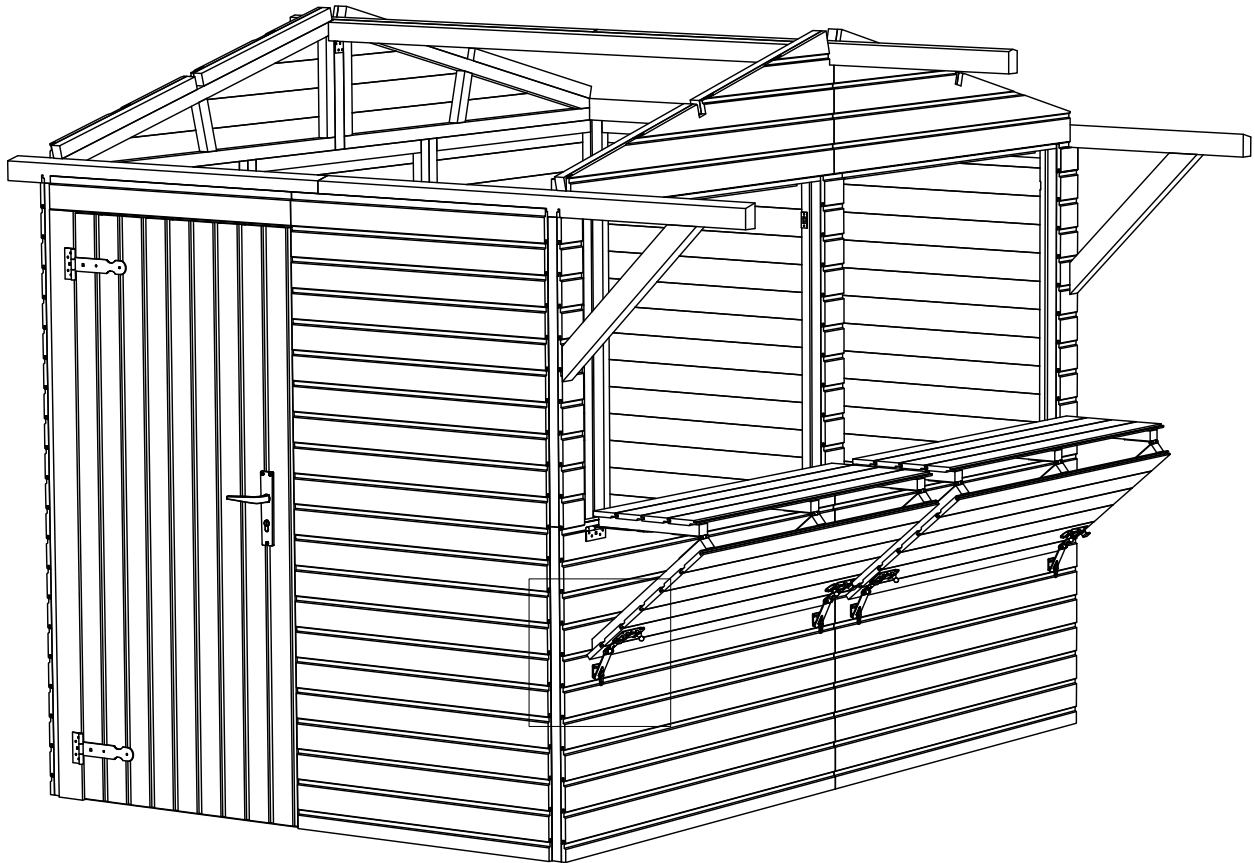
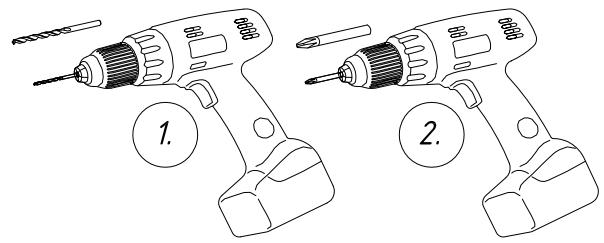



Rel1-1      3      pcs  
 4,5x50      4      pcs  
 6x120      18      pcs

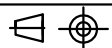
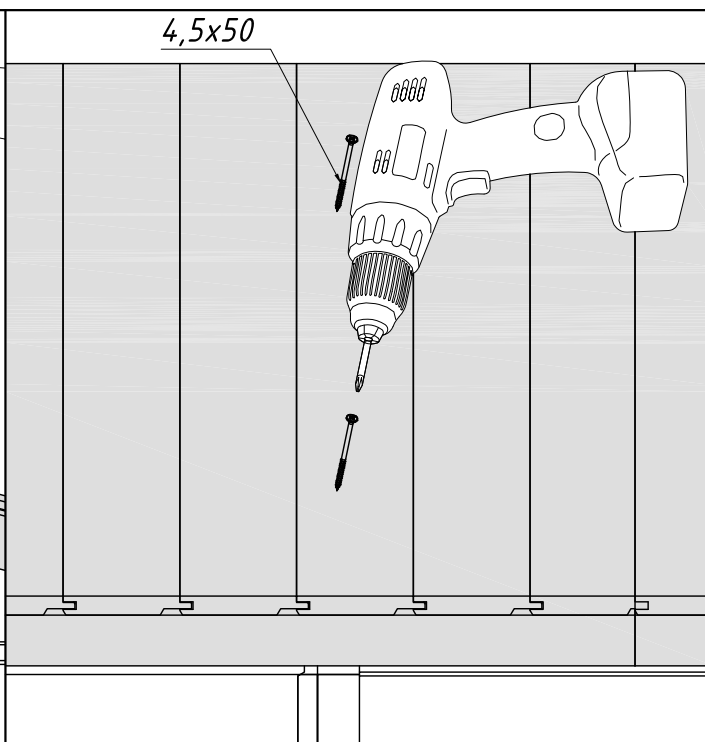
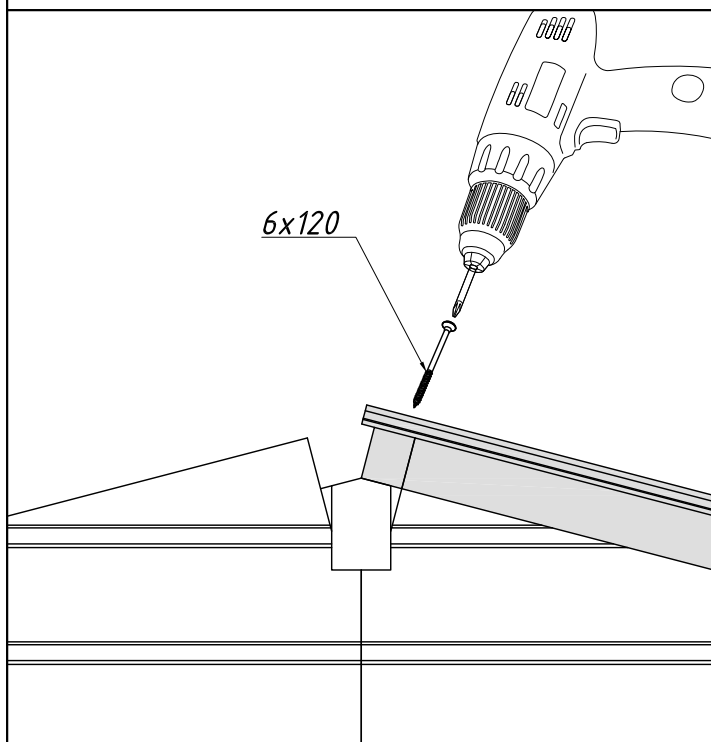
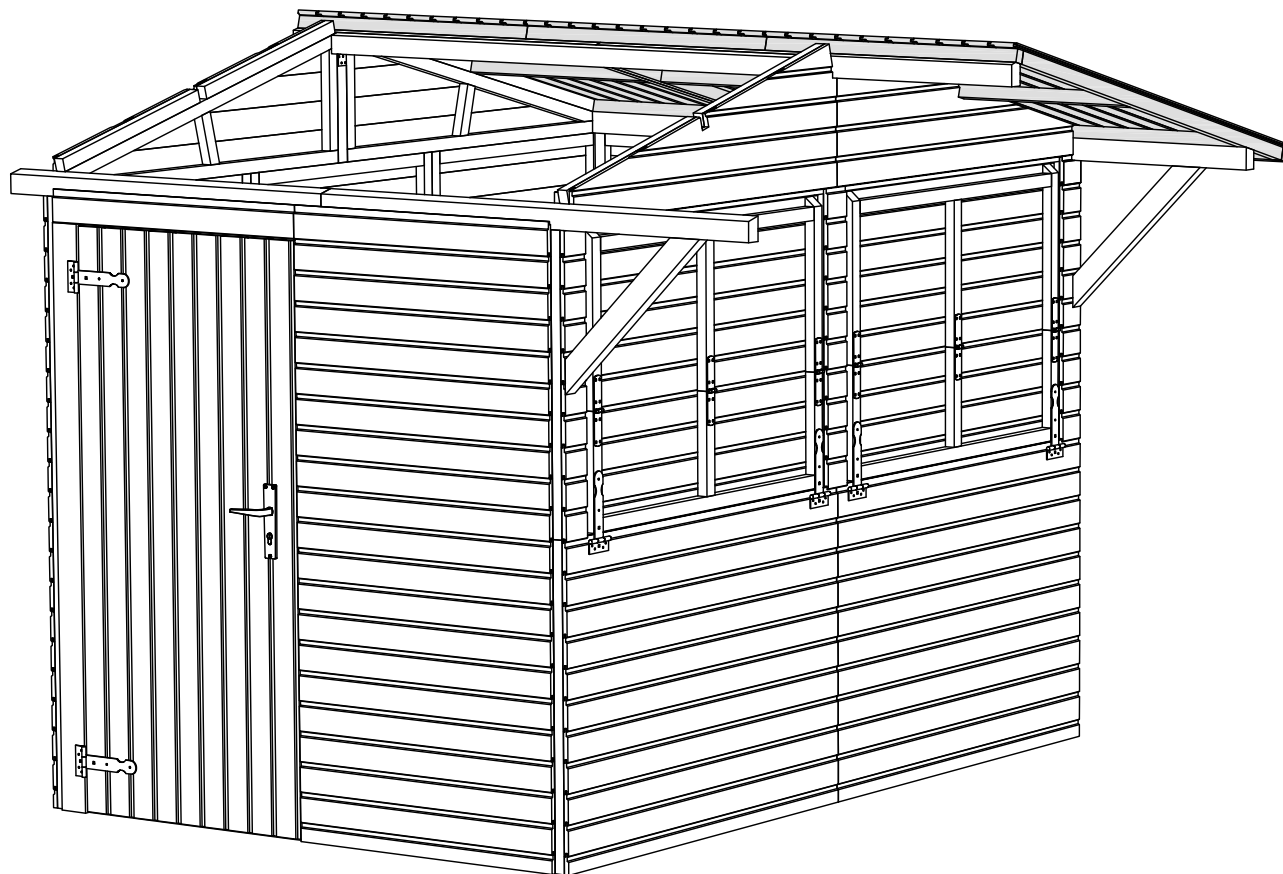
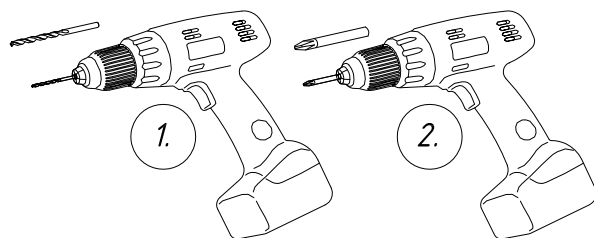

Rel1-1 3 pcs  
4,5x50 4 pcs  
6x120 18 pcs

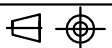
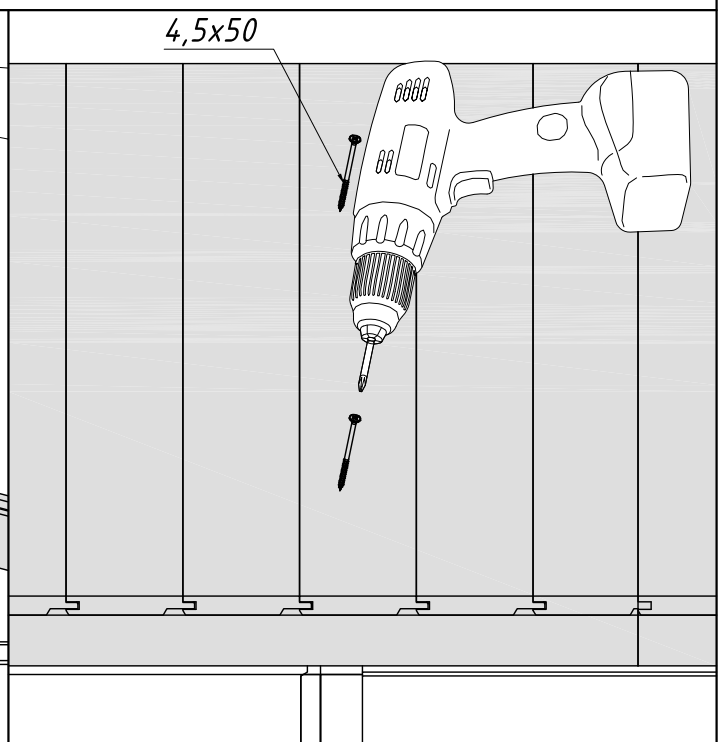
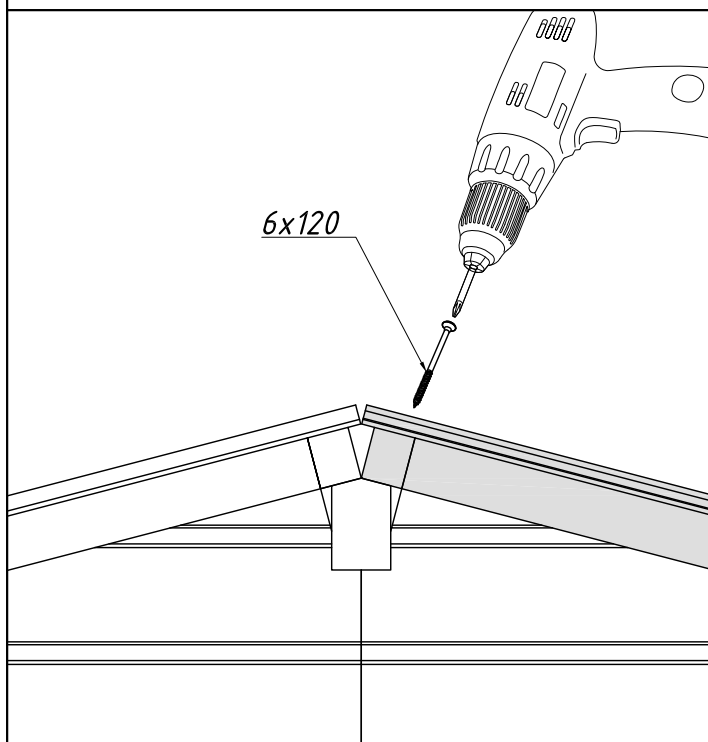
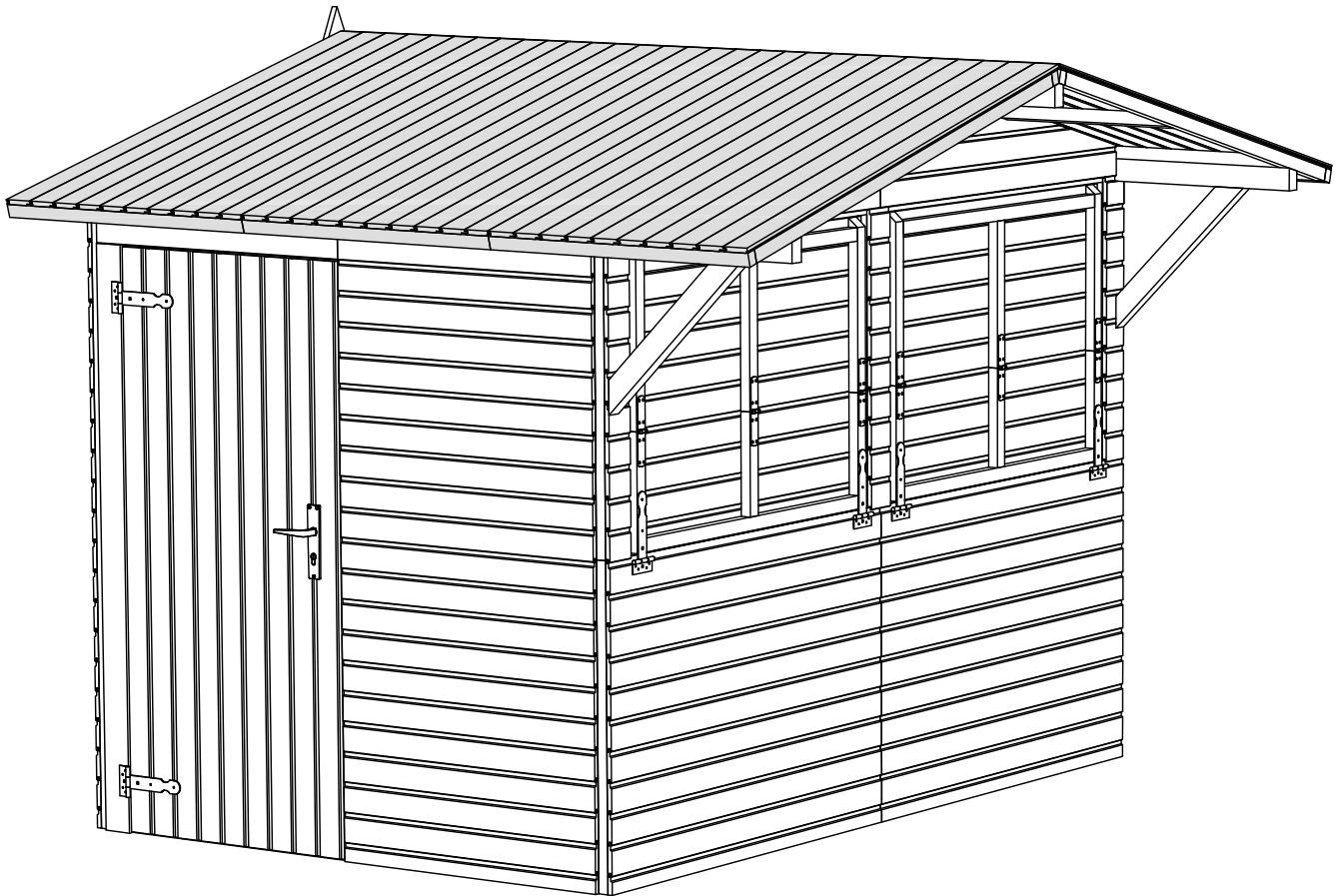
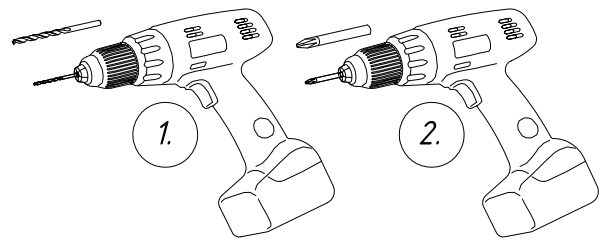

FaB3-1 4 pcs  
Dia-1 2 pcs  
3.5x40 24 pcs

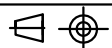
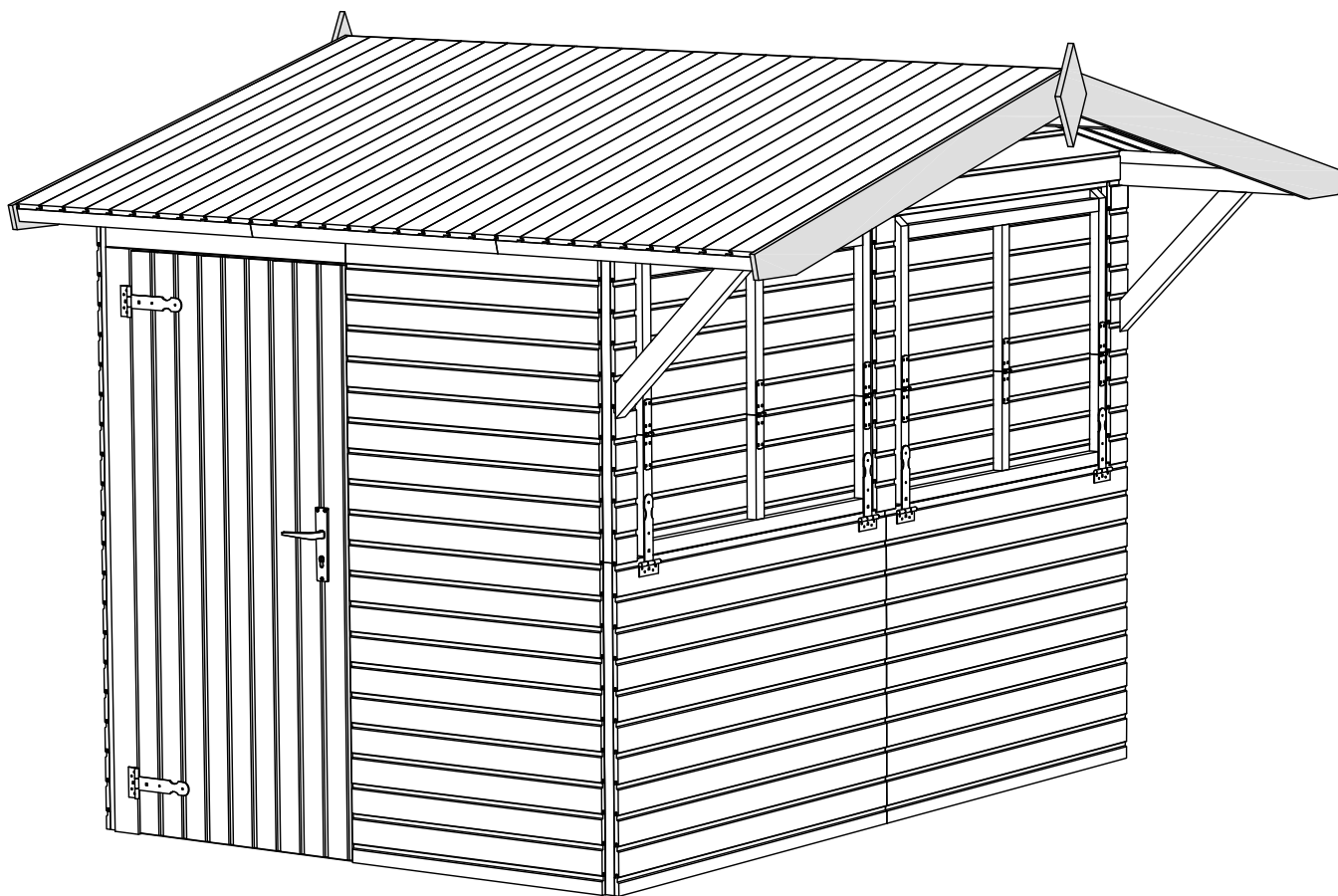
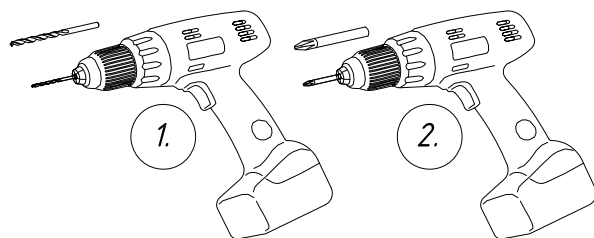

CnB4 1 pcs  
3x30 10 pcs

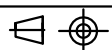
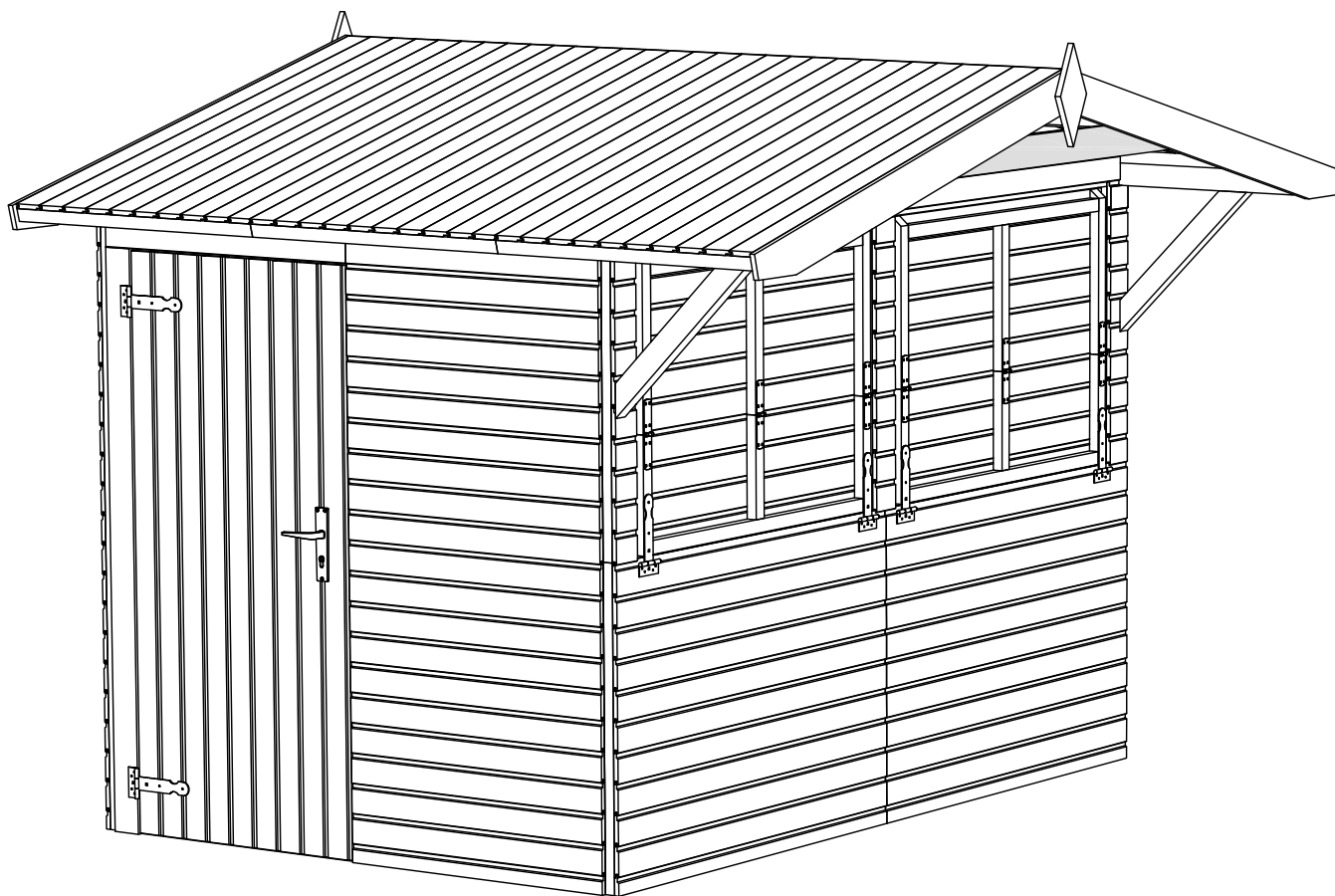
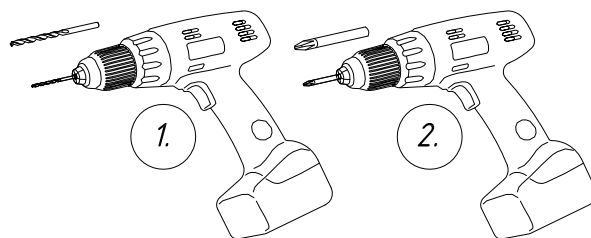

CoB1 1 pcs  
CoB2 8 pcs  
CoB4 1 pcs  
3,5x40 50 pcs

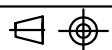
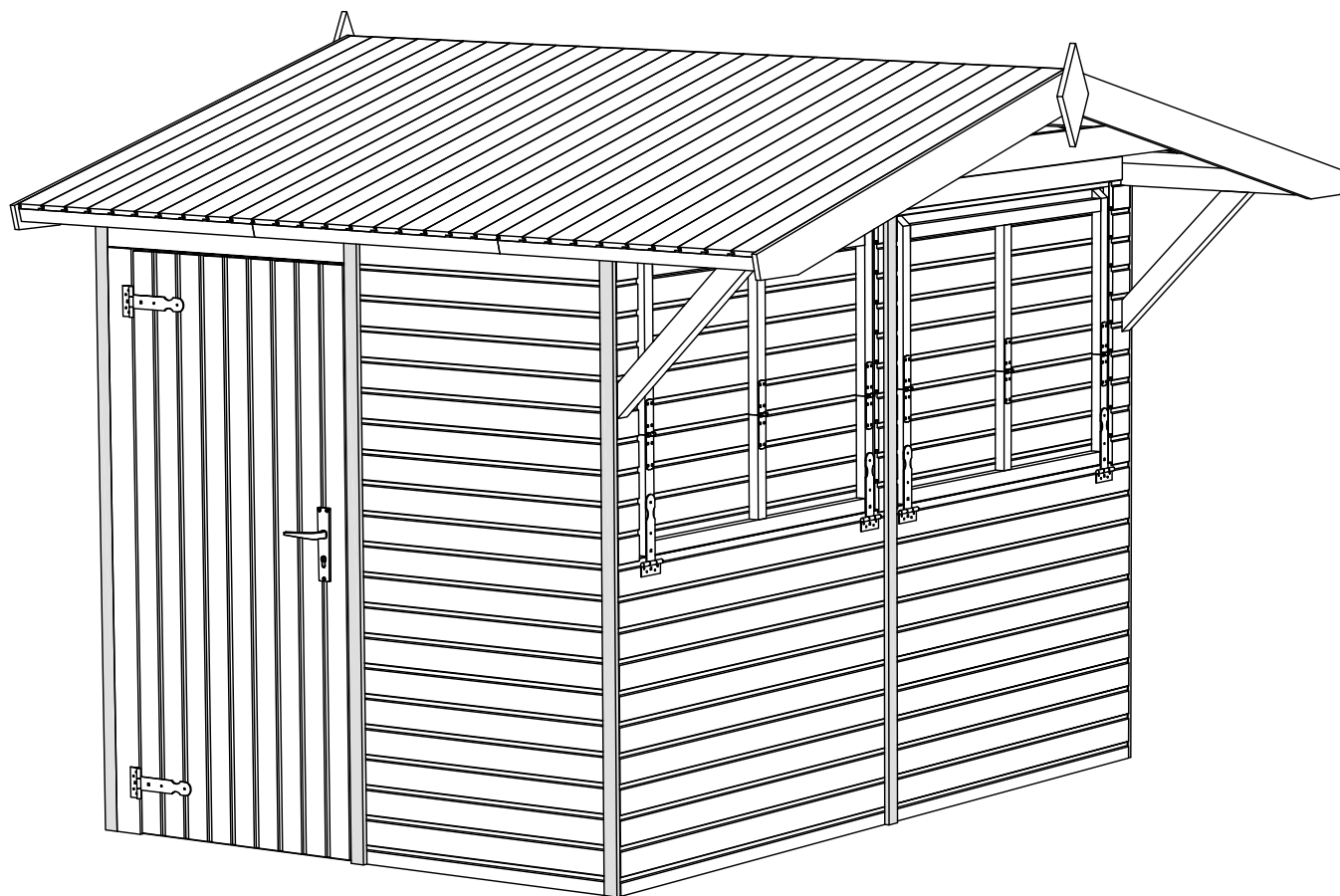
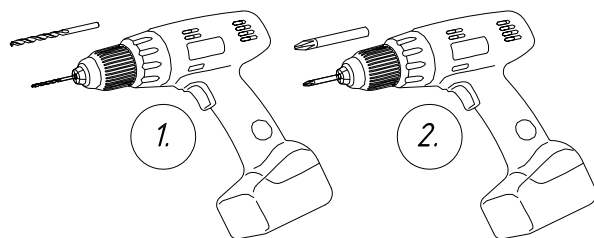

# Inspection Certificate

Controlecertificaat • Kontrollschein • Bulletin de contrôle • Certificato di controllo • Certificado de control • Kontrollskjema • Kontrol Certifikat

## Verkaufsstand 273 cm

22.10.2012

### Please keep safely!

Zorgvuldig te bewaren! • Bitte gut aufbewahren! • A bien conserver, s.v.p.! • Da conservare! • ¡A conservar! • Ta vare på denne! • Opbevares sikkert!

**English:** The house you have purchased was manufactured in accordance with the high quality norms. The building unit has been carefully inspected and packed. In order to avoid possible problems during the assembly carried out by yourself or the building company of your choice, we recommend that you inspect the delivery for its completeness in accordance with the list of pieces before assembly. This inspection must be carried out within 14 days after delivery to your place. Warranty claims are limited to the exchange of defective materials. Defective building parts, which have already been used or painted, are excluded from being replaced. All further claims are excluded! In cases of complaints, please pay attention to the following procedures: Please present this inspection certificate along with the sales receipt to your place of purchase. Only in cases where these documents are presented will the complaint be dealt with quickly and without complications.

**Dutch:** Het door U gekochte tuinhuis werd vervaardigd volgens de hoge kwaliteitsnormen. Het tuinhuis werd zorgvuldig gecontroleerd en verpakt. Om tijdens de montage, uitgevoerd door Uzelf of een door U gekozen aannemer, problemen te vermijden, raden we U aan, vóór de montage, de levering te controleren op volledigheid in overeenstemming met de onderdelenlijst. Deze controle dient te gebeuren binnen 14 dagen na levering bij U thuis. Waarborgvorderingen zijn beperkt tot het vervangen van gebrekkig materiaal. Gebrekkige onderdelen die reeds gebruikt of geschilderd zijn, zijn uitgesloten van vervanging. Alle latere vorderingen zijn uitgesloten! In geval van klachten, gelieve dan te letten op de volgende procedure: Leg dit controlecertificaat, samen met Uw aankoopbewijs voor aan Uw verkoper. Enkel in gevallen waarbij deze documenten voorgelegd worden, zal de klacht snel en zonder complicaties behandeld worden.

**Deutsch:** Das von Ihnen gekaufte Haus wurde nach der hohen Qualitätsnorm gefertigt. Der Bausatz wurde sorgfältig geprüft und verpackt. Um etwaige auftretende Probleme während des Aufbaus durch Sie oder Ihre Aufbaufirma zu vermeiden, kontrollieren Sie bitte die Lieferung auf Vollständigkeit laut Stückliste vor dem Aufbau. Diese Kontrolle muss innerhalb 14 Tagen nach Anlieferung bei Ihnen erfolgen. Ansprüche auf Gewährleistung beschränken sich auf den Austausch von fehlerhaftem Material. Fehlerhafte Bauteile, die bereits verbaut oder gestrichen wurden, sind vom Umtausch ausgeschlossen. Alle weiteren Ansprüche sind ausgeschlossen! Sollte es zu einer Beanstandung kommen, beachten Sie folgende Vorgehensweise: Legen Sie Ihrem Fachhändler diesen Kontrollschein zusammen mit dem Einkaufsbeleg vor. Nur bei Vorlage dieser Unterlagen ist eine schnelle und problemlose Bearbeitung Ihrer Beanstandung möglich.

**Français:** La cabane que vous venez d'acheter a été fabriqué en respectant de hautes normes de qualité. L'ensemble de construction a été testé et emballé avec soin. Afin d'éviter des problèmes éventuels pendant la construction par vous-même ou la société de construction mandatée, nous vous prions de bien vouloir vérifier que toutes les pièces ont été fournies selon la liste des pièces avant que vous ne commenciez la construction. Il vous incombe de faire ce contrôle dans les 14 jours après la fourniture. Les revendications en dédommagement se limitent à l'échange de matériel défectueux. Des pièces de construction défectueuses, déjà construites ou peintes, sont exclues de tout échange. Toutes les revendications ultérieures sont exclues ! Si une réclamation avait lieu, veuillez respecter le déroulement suivant : Il vous faudra présenter, à votre commerçant spécialisé, ce bulletin de contrôle avec le récépissé de l'achat. Ce ne sera que moyennant présentation de ces documents qu'un traitement rapide et sans problème de votre réclamation sera possible!

**Italiano:** La casetta che avete acquistato è stata prodotta secondo la norma di alta qualità. Il kit è stato controllato ed imballato con cura. Per evitare eventuali inconvenienti durante il montaggio, si prega di verificare, prima del montaggio, la completezza della fornitura in base alla distinta dei pezzi. Tale verifica deve essere effettuata entro 14 giorni dalla consegna. Eventuali diritti di garanzia si limitano alla sostituzione di materiale difettoso. Gli elementi difettosi già montati o verniciati sono esclusi dal diritto alla sostituzione. Ogni altro diritto resta escluso! In caso di reclamazione, procedere nel modo seguente: presentare questo certificato di controllo unitamente alla prova d'acquisto al rivenditore. Solo in questo modo la Sua reclamazione potrà essere evasa rapidamente e senza problemi.

**Español:** La casa que ha adquirido ha sido fabricada de acuerdo con normas de alta calidad. Las piezas de la casa han sido cuidadosamente inspeccionadas y embaladas. Con el fin de evitar posibles problemas durante el montaje, hecho por usted o por la empresa de construcción de su elección, le recomendamos revisar el paquete entregado, con la lista de piezas, antes de armar la casa. Haga la revisión dentro de 14 días después de recibir el paquete. La garantía se limita a reemplazar las piezas defectuosas. No se reemplazarán las partes defectuosas que ya hayan sido utilizadas o pintadas. ¡No se aceptan otras reclamaciones! En casos de queja, por favor, presente este certificado junto con la factura en el lugar donde hizo la compra. Sólo presentando estos documentos podremos resolver su problema rápidamente y sin complicaciones.

**Norsk:** Produktet du har kjøpt, ble produsert i henhold til høye kvalitetskrav. Produktet har blitt kontrollert nøye og deretter omhyggelig pakket. For å unngå mulige problemer under monteringen, uansett om du gjør det selv eller får en godkjent håndverker til å gjøre det, anbefaler vi at du kontrollerer leveransen mot delelisten for å se om alle delene er inkludert. Denne kontrollen må gjøres innen 14 dager etter at delene ble levert til din adresse. Garantikrav begrenser seg til bytte av defekte deler. Defekte elementer som allerede har blitt brukt eller malt/beiset/limt, vil ikke bli erstattet. Alle andre krav er utelukket! Dersom du har en reklamasjon, vennligst gjør som følger: Lever dette kontrollskjema med kvitteringen til salgsstedet. Bare når du har med disse dokumentene kan klagen behandles raskt og uten komplikasjoner.

**Dansk:** Det købte hus er fremstillet i overensstemmelse med de høje kvalitetskrav. Produktet er blevet omhyggeligt inspiceret og pakket. For at undgå eventuelle problemer i løbet af monteringen udført af dig selv eller håndværker af dit eget valg, anbefaler vi, at du undersøger leverancen for fuldstændighed i overensstemmelse med listen over dele før samling. Denne inspektion skal foretages inden 14 dage efter levering til din plads. Garantikrav er begrænset til udveksling af defekte materialer. Defekte bygningsdele, som allerede er brugt eller malet, er udelukket fra at blive erstattet. Alle yderligere krav er udelukket! I tilfælde af klager, skal du være opmærksom på følgende procedurer: Vennligst præsenter denne kontrol certifikat sammen med kvitteringen til det sted hvor produktet er købt. Kun i de tilfælde, hvor disse dokumenter er forelagt kan klagen behandles hurtigt og uden komplikationer.

Factory inspection by • Fabriekscontrole door • Werkskontrolle durch • Contrôle à partir de l'usine par • Collaudato da • Inspector de fábrica • Fabrikkkontroll utført av • Fabriks Kontrol udført af :

Pack number • Pack Nr. • Pack Nr. • Packet n° • Pacco N. • Paquete N° • Serienr:

Date • Datum • Date • Data • Fecha • Dato:.....

**To be completed by buyer! (Please use block letters)** • In te vullen door de verkoper! (Graag in drukletters) • Vom Käufer auszufüllen! (Bitte in Druckschrift) • A remplir par l'acheteur! (en lettres d'imprimerie, s'il vous plaît) • Da compilare dall'acquirente! (in stampatello) • ¡Completa el cliente! (en mayúsculas) • Fylles ut av kjøper! (Vær vennlig å bruke blokkbokstaver) • Udfyldes af køber! (Benyt venligst Blokkbogstaver):

**Place of purchase** • Plaats van aankoop • Bezugsquelle • Source d'achat • Acquistato presso • Lugar de compra • Salgssted • Salgs sted:

**Sales receipt No.** • Aankoopbewijs Nr. • Kaufbeleg-Nr. • Récépissé n° • Prova d'acquisto N. • Recibo N° • Kvitteringsnr • Kasse Bon nr

**Delivery date** • Leveringsdatum • Lieferdatum • Date de livraison • Data di consegna • Fecha de Entrega • Leveringsdato • Leverings dato:

**Buyer's address** • Adres koper • Kundenanschrift • Adresse du client • Indirizzo del cliente • Dirección del cliente • Kjøpers adresse • Købers adresse :

**Telephone** • Telefoon • Telefon • Téléphone • Teléfono • Telefon • Telefon nr:

**Sales receipt date** • Aankoopbewijs -Datum • Kaufbeleg-Datum • Date du récépissé • Data prova d'acquisto • Fecha recibo • Kvitteringsdato • Kasse bons dato:

**Forwarder:**  Pick-up  Others • Door:  Verzending  Zelf afhalen  Spedition  Selbstabholer • Par:  Transporteur  Propres moyens • Tramite:  Spedizioniere  Mezzo proprio • Entrega: Transporte organizado  transporte propio • Transportør:  Sendes  Hentes • Transportør:  Sendes  Hentes

**Description of complaint** • Beschrijving van de klacht • Schilderung der Beanstandung • Description de la réclamation • Descrizione della reclamazione • Descripción del problema • Beskrivelse av feil/ mangel • Beskrivelse af fejl / Mangel: **Please keep the parts which are the object of the complaint until the complaint is settled!** • Gelieve de betrokken onderdelen te bewaren tot de klacht is afgehandeld • Veuillez garder les pièces contestées jusqu'à ce que la réclamation soit traitée définitivement! • Si prega di conservare i pezzi reclamati fino all'evasione della reclamazione! • Por favor, conserve las piezas objeto de la queja hasta que el problema haya sido resuelto • Please Vær vennlig å ta vare på de aktuelle delene/ produktet inntil saken er avsluttet! • Venligst ta hånd om de aktuelle dele / produkt indtil sagen er afsluttet!